

HDMI 4 by 1 Switcher

- ID# 877



Operation Manual

Introduction

This is a high performance four-input & one-output High-Definition Multimedia Interface (HDMI) v1.4 switcher with digital audio inputs and outputs. It supports HDCP repeater functions and fast switching between any of the four of HDMI input ports. The system supports all 3D TV formats in addition to all HDTV formats up to 1080p 12-bit Deep Color. Furthermore, the remote control gives users complete control over the selection of sources and makes the device incredibly user friendly.

Features

- Support multiplexed HDMI 4-input and 1-output
- HDMI 1.4, HDCP 1.4 and CEC1.4 compliant
- HDMI 1.4 support:
 - ✓ Audio Return Channel (ARC)
 - ✓ 3D TV support
 - ✓ CEC1.4
- Fast switching on all HDMI input ports
- Character and icon based On-Screen Display (OSD)
 - ✓ System information for Software version
 - ✓ Sink EDID
 - ✓ Source info frame
 - ✓ HDMI input Audio & Audio Return selection
- HDCP repeater support
- Deep Color support 36/30/24-bit, 1080p@60Hz
- HDMI cable distance tested with 1080p 8/12 bits resolution, the input & output distance can be up to 10 & 15 meters.
- Audio support:
 - ✓ HDMI 1.4 compatible audio interface
 - ✓ Dedicated, flexible audio input/output port
 - ✓ Dolby TrueHD
 - ✓ DTS-HD Master Audio 7.1CH
 - ✓ Full audio input and output support

Applications

- Display 3D content
- Multi-source selection and display
- Display HDMI v1.4 content
- Electronic retail display

System Requirements

Input source equipment with or without 3D content and HDMI connection cables. HDTV output displays that support or don't support 3D and HDMI connection cables.

Operation Controls and Functions

Front Panel

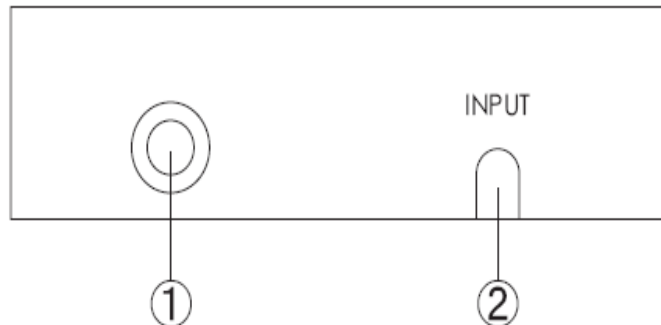

- ①. **IR sensor:** This is a IR receiver window that receives IR signals from the remote control included in the package.
- ②. **INPUT:** Press this button to select the desired input source, the LED will switch on according to the selection.

Rear Panel

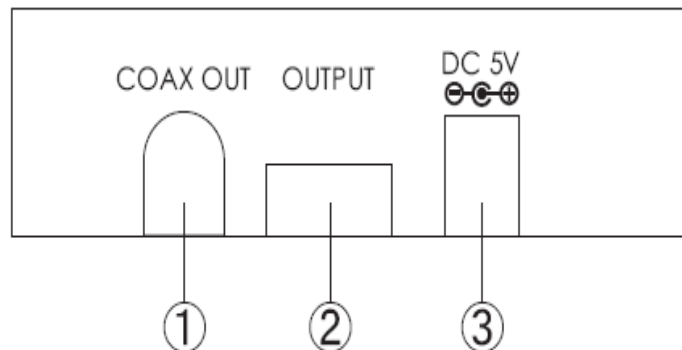

- ①. **COAX OUT:** This slot is where you connect an amplifier for transmitting an audio signal with coaxial cables. When the audio return function is on the audio signal will be received from the output and when the audio return function is off the audio signal will be received from the input source.

This device only supports PCM 2CH.

Note:

1. The display TV or monitor must support an audio return function and the function must be turned ON in order to perform the audio return.
 2. The display TV or monitor's HDMI input jack must be connected to the device with an audio return function.
- ②. **OUTPUT:** This slot is where you connect with an HDTV or HD display that does support or does not support 3D signals for sending an input signal to the display with an HDMI cable.

③ **DC 5V:** Plug the 5V DC power supply into the unit and connect the adaptor to an AC outlet. The LED will switch on when the power cable is plugged in.

Right Panel

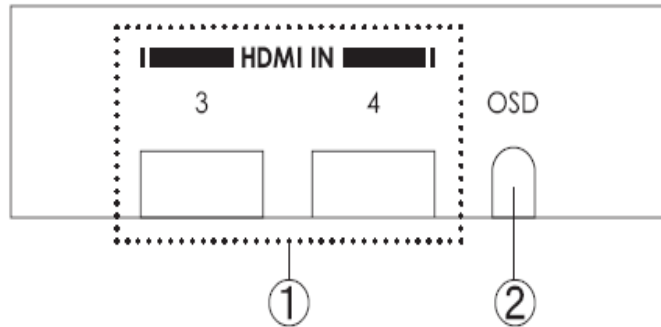

- ①. **HDMI IN 3 & 4:** These slots are where you connect the input source devices for sending a signal to the input source with HDMI cables.
- ②. **OSD:** Press this button to bring up the OSD on the display and press it again to turn it off.

Left Panel

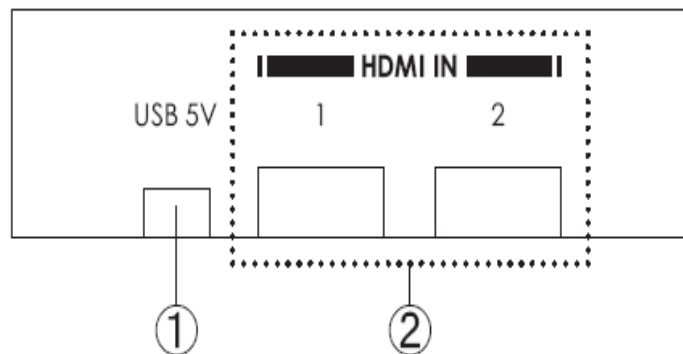

- ①. **USB 5V:** This slot is where you can connect the mini USB cable from your PC to the device in order to supply power.
- ②. **HDMI IN 1 & 2:** These slots are where you connect the input source devices for sending an input signal with HDMI cables.

Top Panel

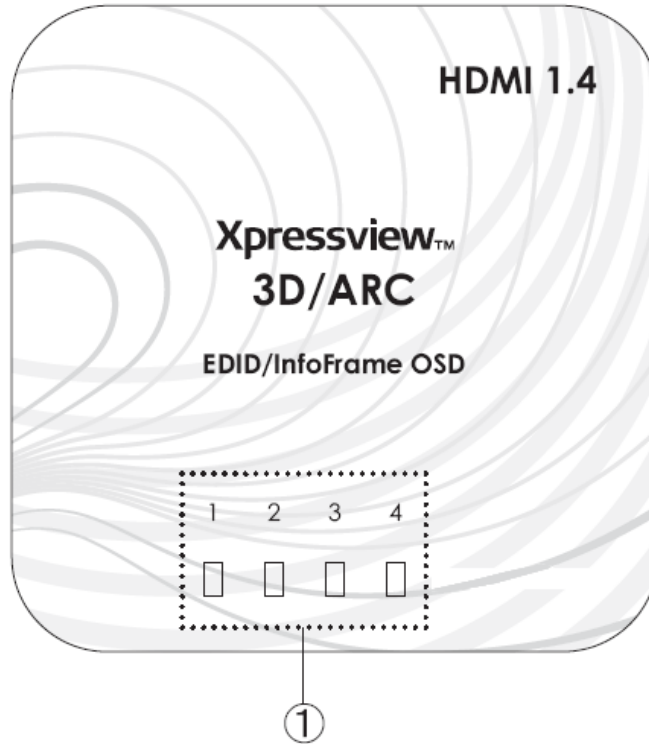

- ①. **Input LED 1~4:** These LED will switch on according to user's input selection.

Remote Control

- ① MENU: Press to enter into menu selection, an OSD will appear from the display.
② Enter: Press to confirm the selection.
③ 1, 2, 3, 4: Press to select input port.
④ ▲▼◀▶: Use these buttons to select/adjust OSD menu's object.

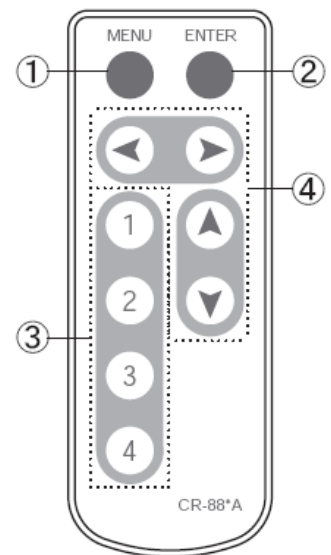

RS32 Commands

Pin assignment

The connection between Switcher and remote controller with RS-232 modem cable.

Switcher			Remote Controller	
PIN	Definition		PIN	Definition
1	NC		1	NC
2	TxD		2	RxD
3	RxD	→	3	TxD
4	NC		4	NC
5	GND		5	GND
6	NC	←	6	NC
7	NC		7	NC
8	NC		8	NC
9	NC		9	NC

Baud Rate: 115200 bps

Data bit: 8 Bits

Parity: None

Stop Bit: 1 bit

Flow Control: None

System Info

Press [▲/▼] to highlight an option

Press [Enter] to check the input/output device information and software version.

Press [MENU] to exit menu

Press [Enter] to confirm/exit the selection

Sink Edid

Press [▲/▼] to highlight an option

Press [◀/ ▶] to select the option

Press [Enter] to confirm/exit the selection

Press [MENU] to exit menu

Option	Description
Block Data	To check the sink Block0 and Block1's table of EDID
Description	To check the sink description of EDID

Source Infoframe

Press [▲/▼] to highlight an option

Press [◀/ ▶] to select the option

Press [Enter] to confirm/exit the selection

Press [MENU] to exit menu

Option	Description
AVI (AVI infoframe data)	To check the source video infoFrame Packet
AUD (Audio infoframe data)	To check the source audio infoFrame Packet

Input Select

Press [▲/▼] to highlight an option
 Press [◀/▶] to select the option
 Press [Enter] to confirm the selection
 Press [MENU] to exit menu

Audio Return

Press [▲/▼] to highlight an option
 Press [◀/▶] to select the option
 Press [Enter] to confirm the selection
 Press [MENU] to exit menu

Option	Description
Audio Return	On/Off

Exit

Press [↑/↓] to highlight an option
 Press [Enter] to confirm/exit the selection

Connection

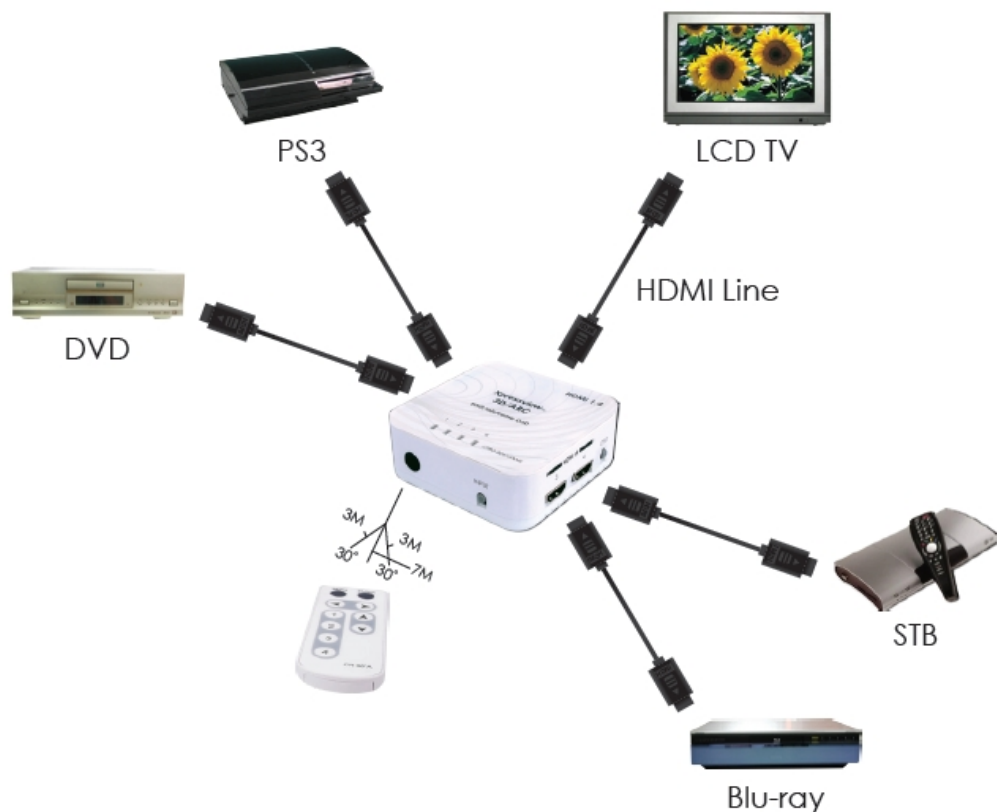

Specifications

Frequency Bandwidth	2.25Gbps
Input Ports	4 x HDMI Female ports
Output port	1 x HDMI Female port
HDMI Audio Output	PCM2, 5.1, 7.1CH, Dolby 5.1, DTS5.1, DD+, D-TrueHD, DTS-HD
HDMI Cable In	1080p 8-bit (10M), 12-bit (10M)
HDMI Cable Out	1080p 8-bit (15M), 12-bit (15M)
Coaxial Audio Output	PCM2CH
Power Supply	5V/1A DC (US/EU standards, CE/FCC/UL certified)
ESD Protection	Human Body Model: ± 8kV (air-gap discharge) ± 4kV (contact discharge) 100 (W) x 70 (D) x 20 (H)
Dimensions (mm)	
Weight (g)	90
Chassis Material	Plastic
Silkscreen Color	White
Power Consumption	4W
Operating Temperature	0°C ~ 40°C / 32°F ~ 104°F
Storage Temperature	-20°C ~ 60°C / -4°F ~ 140°F
Relative Humidity	20~60% RH (non-condensing)