

# HDMI to USB capture Box - ID# 926



**Operation Manual**

## Introduction

The HDMI to USB capture box is High Definition capture box supports HDMI 1080p video input and record to H.264 video format. Its low power consumption and superior video processing capabilities make it ideal for integration into high-end portable and desk top PC products

## System Requirement

In order to run the application smoothly, please refer to the following hardware recommendation.

- System Hardware Requirements:  
2.4 GHz single core CPU with at least 1GB RAM for optimal performance
- Operating Systems:  
Windows 2K SP4  
Windows XP Home or Professional 32 bits SP2  
Windows Vista 32 bits  
Windows 7 32 bits
- USB Port Extension:  
An available USB 2.0 port with USB to mini USB cable

## Features

- FullHD capture HDMI to USB
- H.264/MPEG4-AVC High Definition encoder
- Video input supports: 1920 x 1080i/p, 1280 x 720p, 576i/p, 720 x 480i/p
- Supports MPEG-4 Advanced Audio Coding (AAC)
- 48 KHz audio sampling frequencies
- It use USB bus power for low power consumption

## Applications

- Displaying HD signal on PC or NB's monitor

## Operation Controls and Functions Front Panel

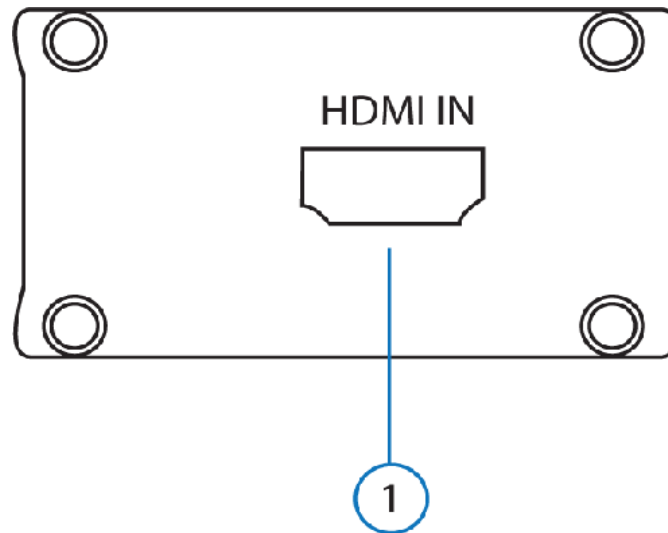

1. **HDMI IN**  
This slot is where you plug your input source equipment with HDMI cable for input signal sending.

## Back Panel

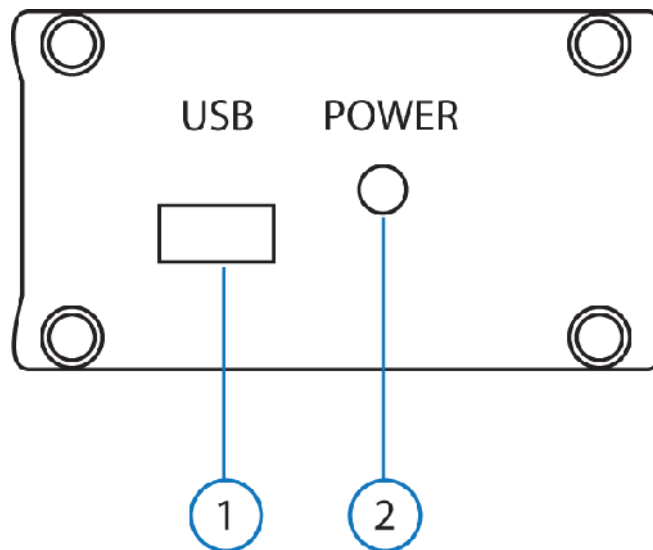

1. **USB**  
This slot is where you plug the mini USB cable and connect it to the PC/NB for data upstream and power.
2. **Power LED**  
This LED will illuminate when the device is connected.

## Hardware Installation

Connect the HDMI to USB Full HD Capture to NB/PC with mini USB to USB type A cable and the LED will illuminate in green with a Found New Hardware message from NB/PC desk screen



A Wizard dialogue will appear, click "Yes", and click "Next" to continue the installation



Insert the CD driver included in the package now and tick on "Install the software automatically" then click "Next".

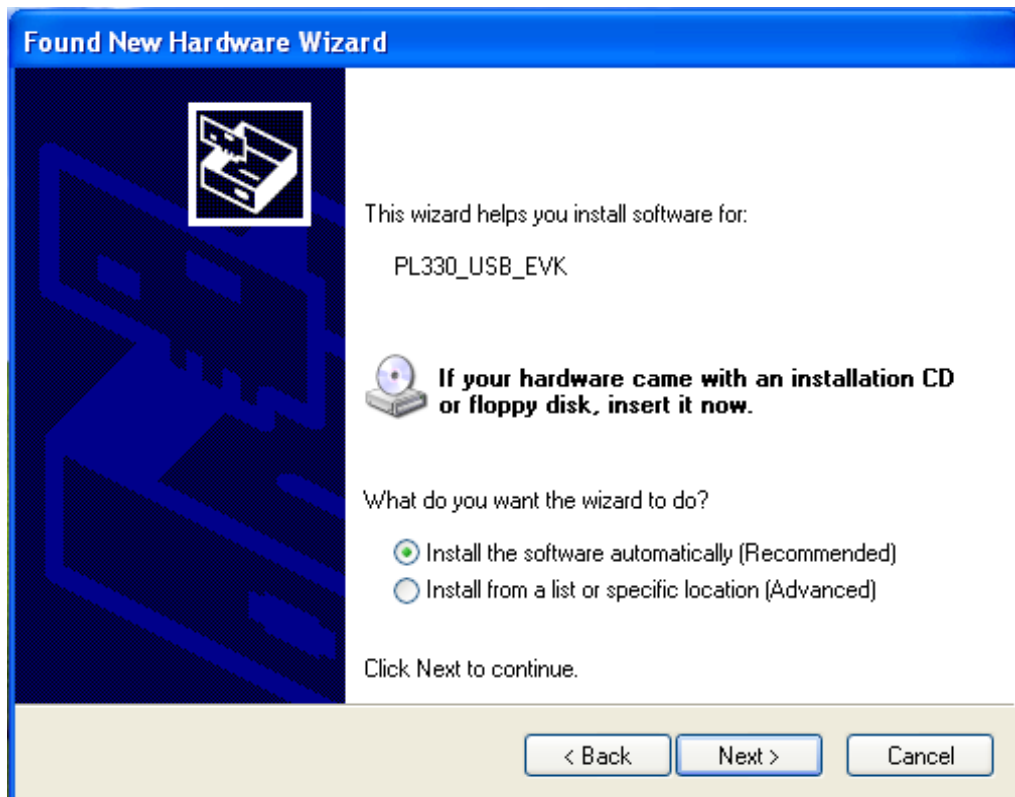

Another dialogue will appear as below. Tick "Search" and click on "Next" to continuing the installation.

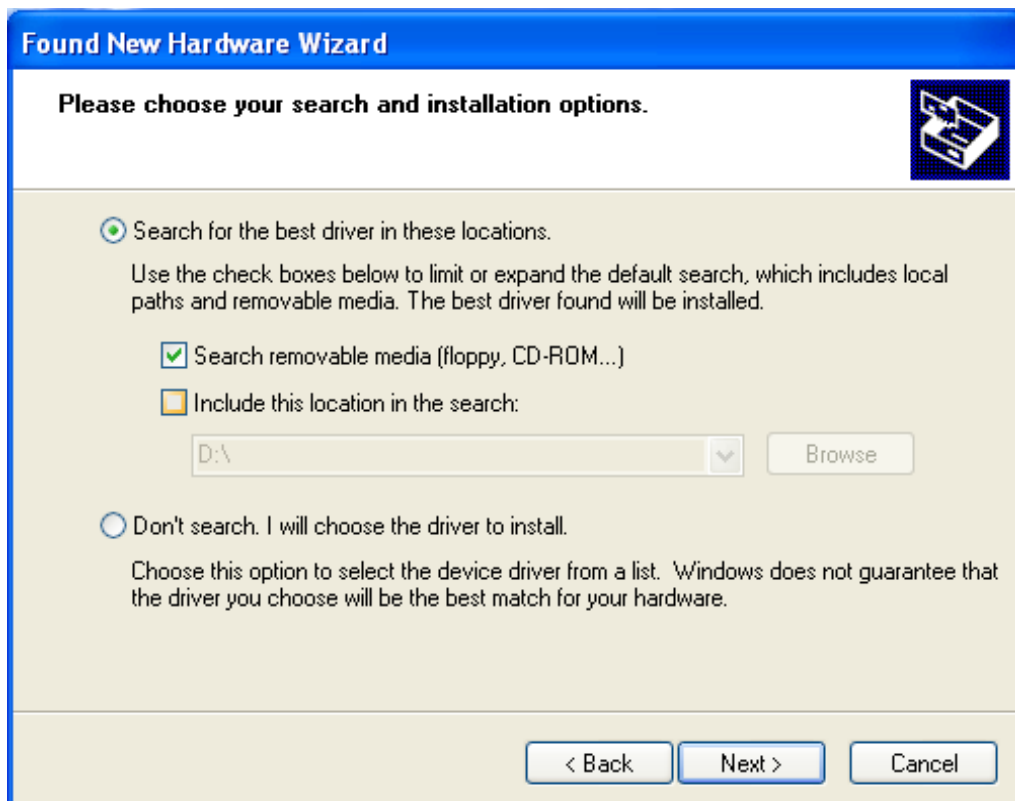

Allowing the Wizard to search and find the proper installation file for a while and click "Finish" to complete the installation.

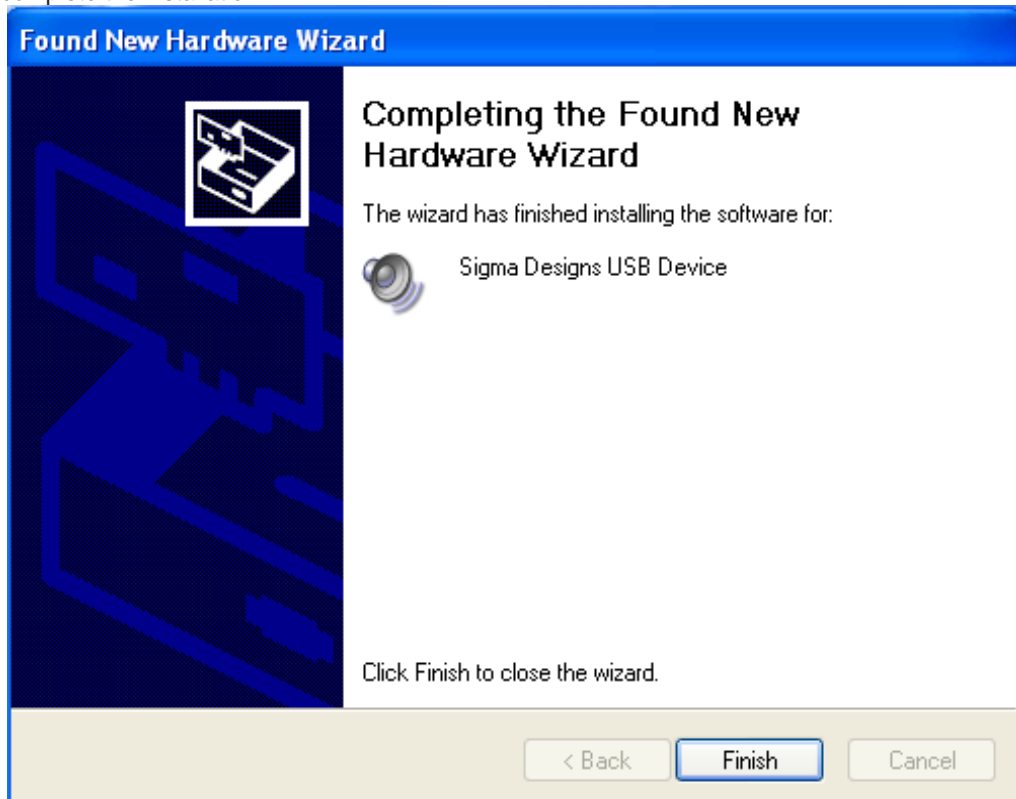

### Software Installationon

Download "DivXInstaller.exe" from the website: <http://www.divx.com/en/software/divx-plus> and click on the "FREE DOWNLOAD" to install it. Run and click the "AUTORUN.EXE" in your CD root directory and click on PL 330 to install.



The setup dialogue of PL330 will appear, click "Next" to continue the setup.

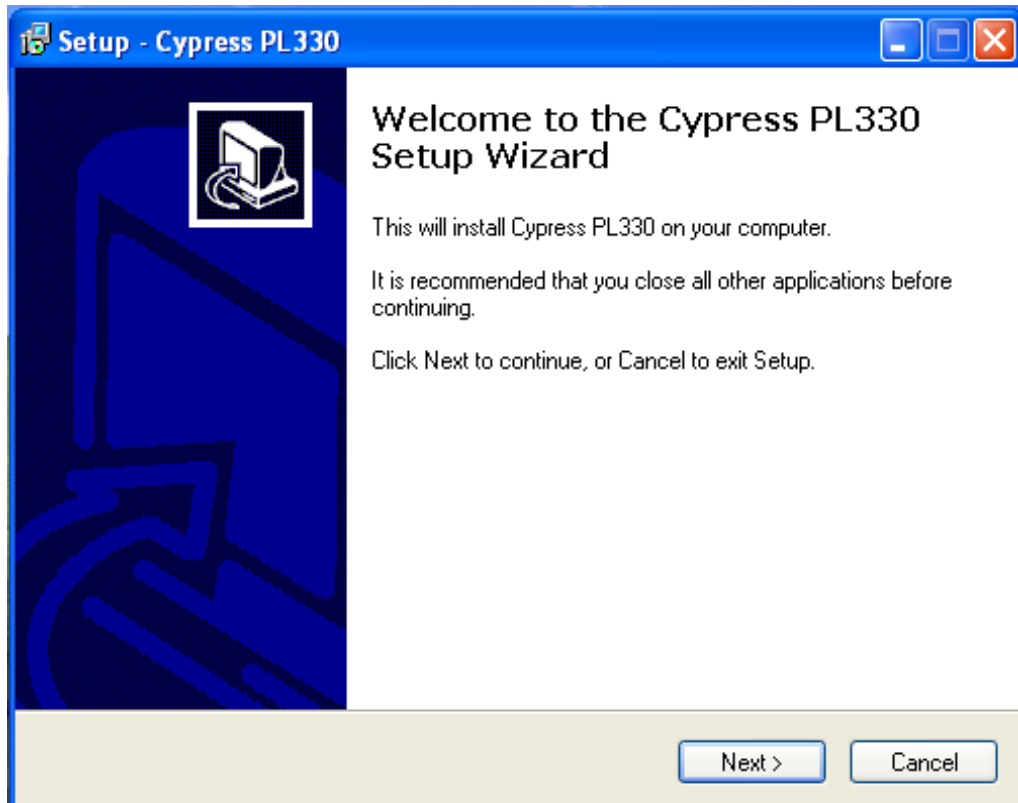

Allowing the setup to process for few moments and select a destination location for saving the PL 330's folder. Users are free to set the destination location and it is recommended to save it under the easy finding place.

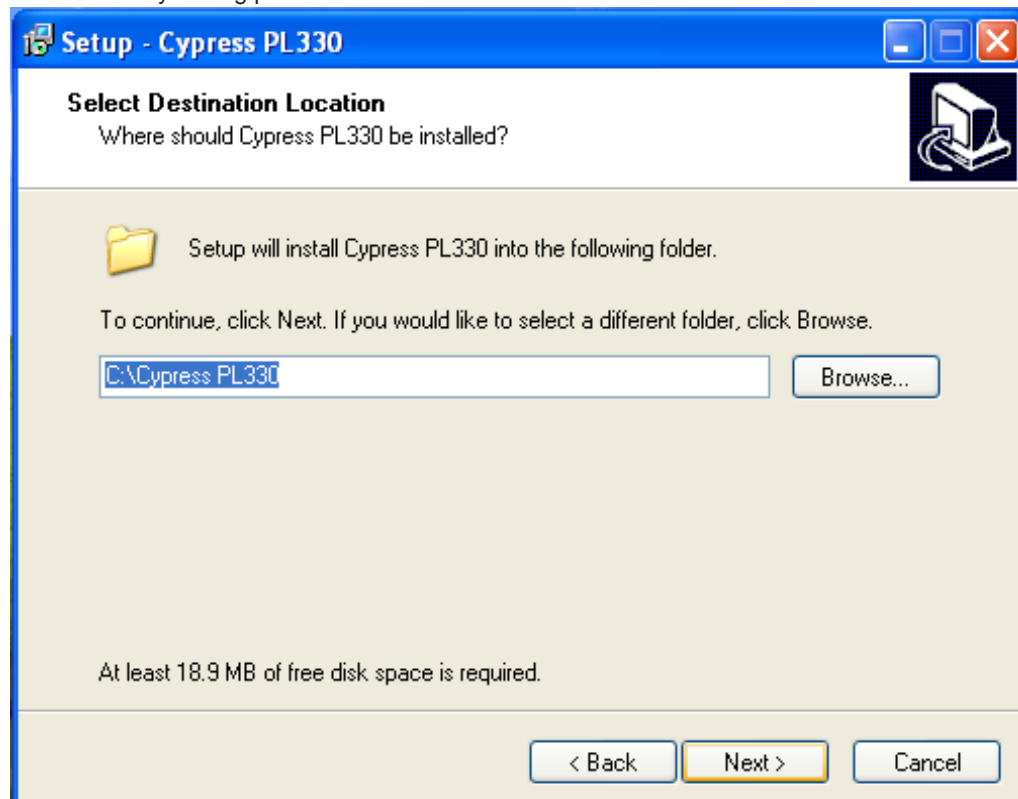

Click "Install" to confirm the installation.

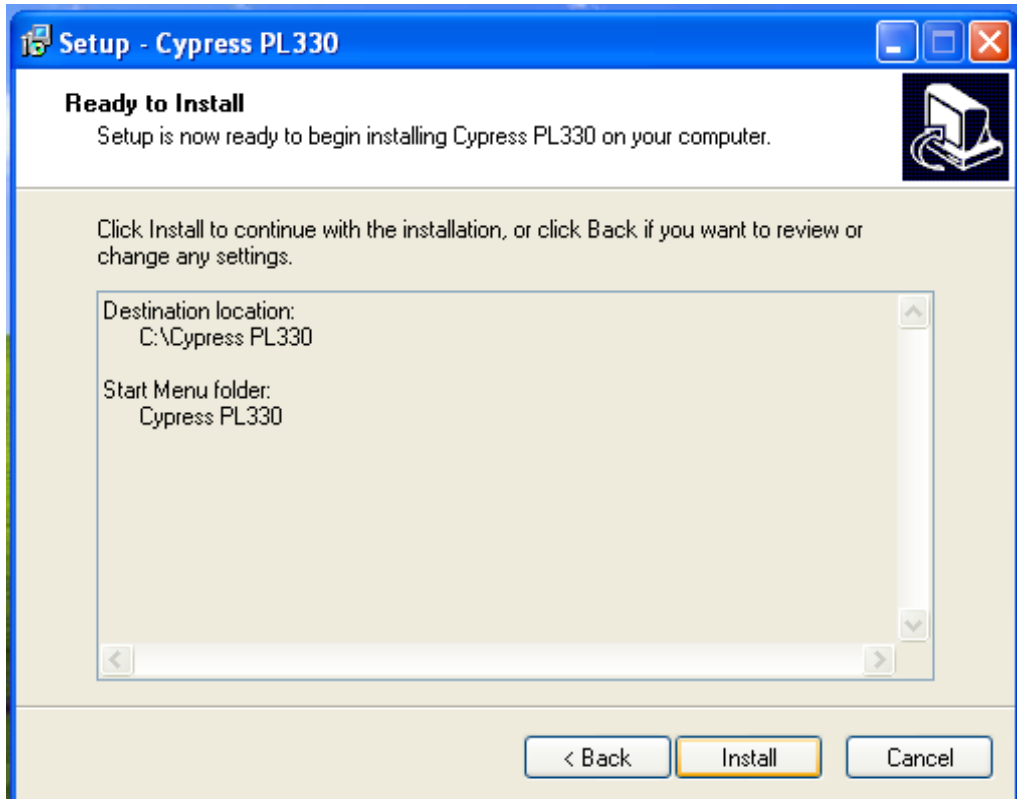

Click "Finish" again to complete the PL330's installation.

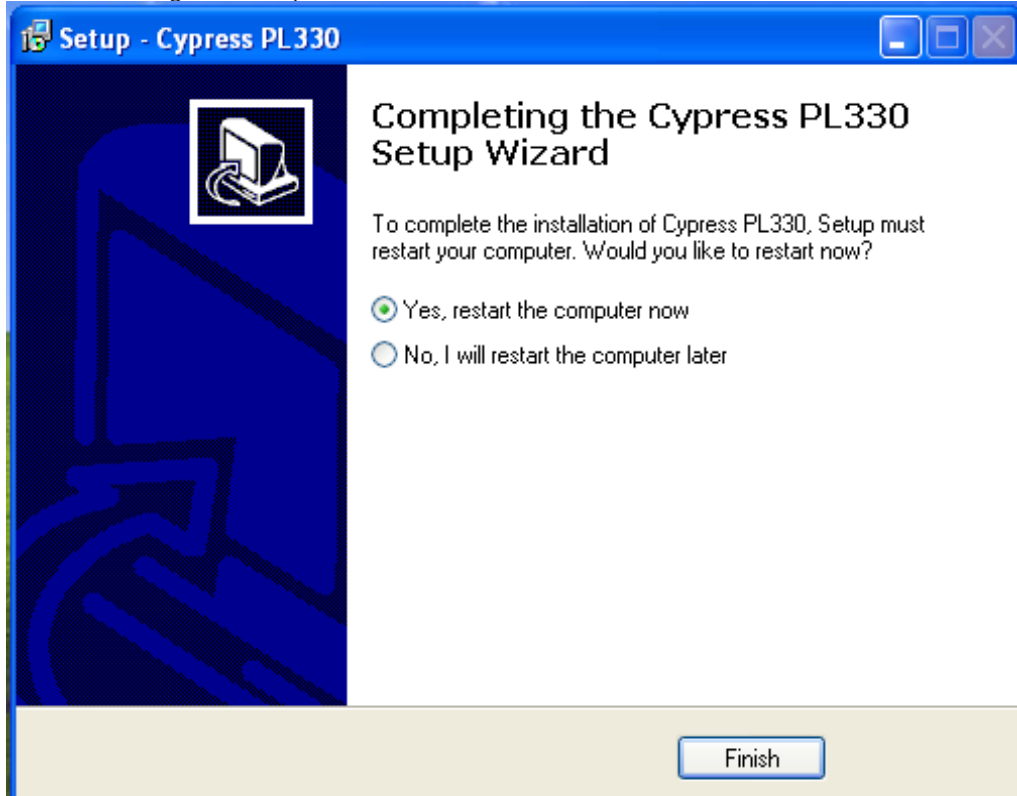



Then click on Exit to finish the installation.



Cypress PL330's icon should appear on the desk



Double click on the Cypress PL330 to set the configuration of HDMI to USB FullHD Capture.



Select CUSB-601H and click on "OK".

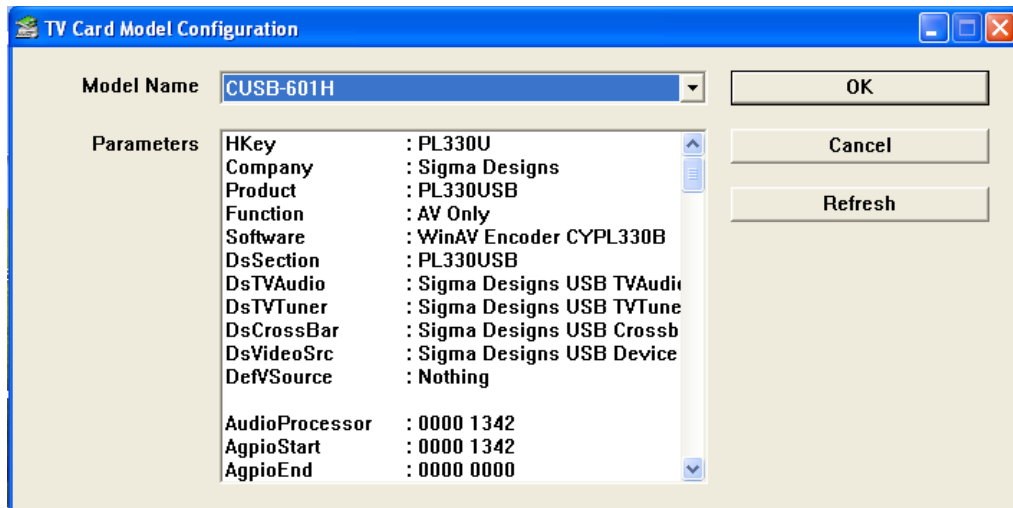

Select your AV system of NTSC or PAL, language and Video type then click on "OK"

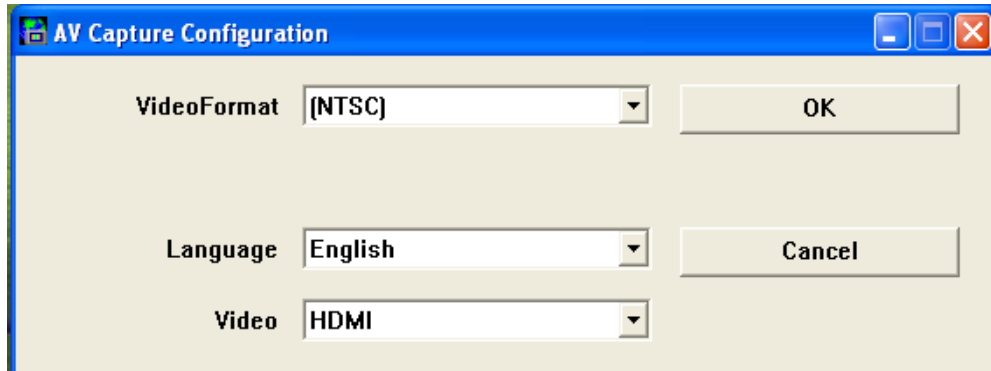

A DVR player will appear on the screen



### DVR Panel's Functions

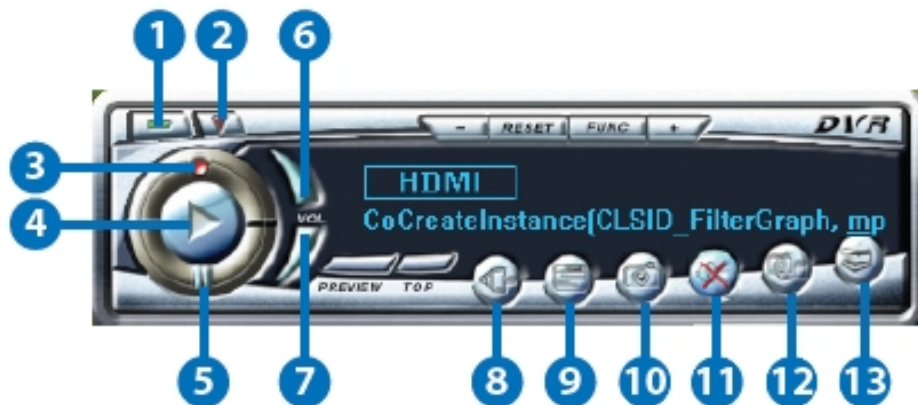

**1 Power**

Click this button to exit the application.

**2 Minimize**

Click this button to minimize the control panel.

**3 Record**

Click this button to save the video file.

**4 Play**

Click this button to play the video file from the recorded file.

**5 Pause**

Click this button to pause the video.

**6 Vol up**

Click this button to volume up the sound.

**7 Vol down**

Click this button to volume down the sound.

### 8 Source

Click this button to select the source input from the DVD/TV input connection.

### 9 Video Setup

Click this button to set the video and audio's parameter. A dialogue will appear as below, please set the parameter accordingly

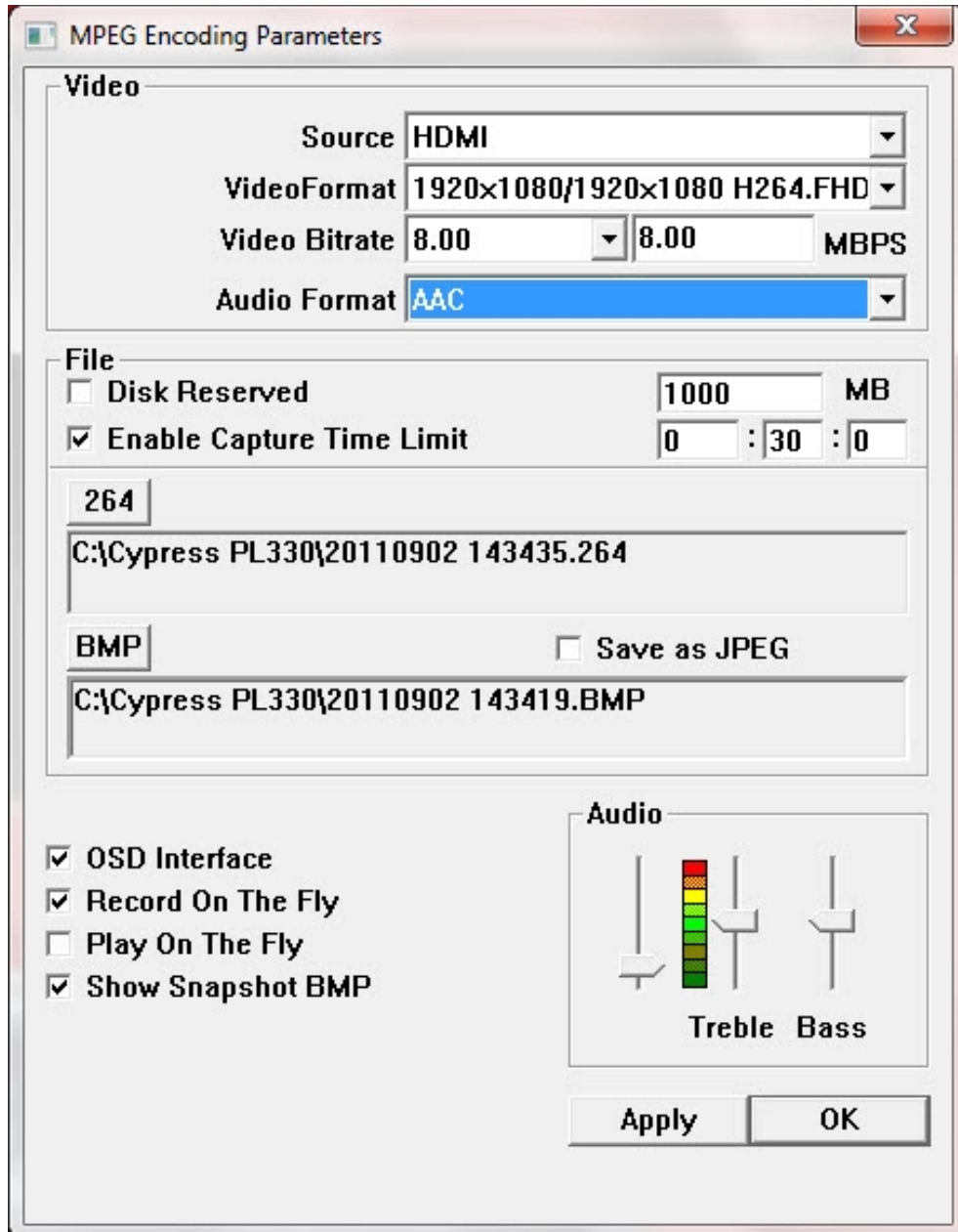

### 10 Save Clipboard

Click this button to copy the image for other DDE application.

### 11 Mute

Click this button to mute the audio.

### 12 Snapshot BMP

Click this button to save the still image as the BMP or JPEG file.

### 13 Help

Click this button to enable the online help tool.

## Specifications

Input port	1x HDMI
Output port	1 x USB
Power Supply	5V/500m A DC USB bus
Dimensions	121 mm (W) × 21.6 mm
Weight	16g
Chassis Material	Aluminum
Silkscreen Colour	Black
Power Consumption	0.5 W
Operating Temperature	0 °C~40 °C / 32 °F~104
Storage Temperature	-20 °C~60 °C / -4 °F~140
Relative Humidity	20~90 % RH (non-condensing)

## Connection

