

HDMI 6G Audio Bridge with Pattern Generator - # 15421



Operation Manual

Introduction

The 4K2K HDMI 6G Pattern Generator with Audio Bridge is an advanced and convenient tool for generating HDMI 6G signals for testing HDMI devices. With 6 built-in settings covering Ultra HD and Full HD resolutions, 4 test patterns, HDCP (1.4, 2.2 and non-HDCP) and 2 audio types each providing a large array of test patterns, and incorporates both digital and analog audio inputs for embedding into an HDMI output. The colorful LED design allows fast and easy selection of patterns and quick viewing of the current status.

Applications

- Production testing
- R&D design and testing

Features

- HDMI with 4K2K 6G supported and HDCP 2.2 compliant
- Generate HDMI timings up to 6Gbps 4K2K@60
- Generate HDCP v1.4/v2.2 and non-HDCP signal
- Supports external analog stereo and optical digital audio inputs

System

Requirements

Input audio source signals with output HDMI display/monitor and connection cables.

Operation Controls and Functions

Front Panel

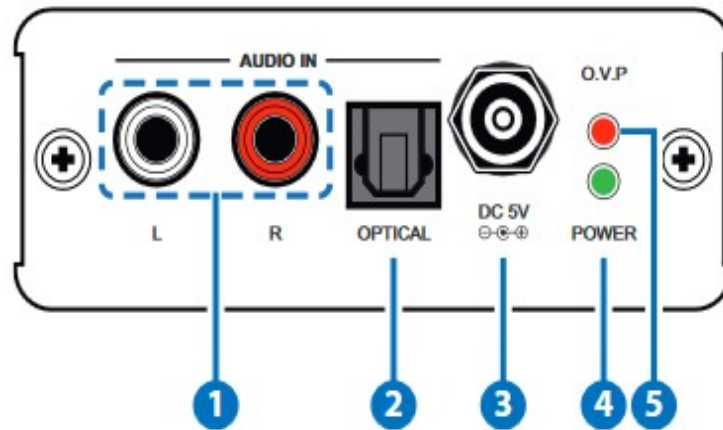

1. AUDIO IN L/R:

Connect from audio source equipment with L/R cables.

2. AUDIO IN OPTICAL:

Connect from audio source equipment with optical cable.

3. POWER:

Plug the 5V DC power supply into the unit and connect the adaptor to an AC outlet.

4. POWER:

This LED will illuminate when the device is connected with power supply.

5. O.V.P.(Over Voltage Protection):

This LED will illuminate when the input power supply exceed from 5V to 28V and the device will be terminated.

Rear Panel

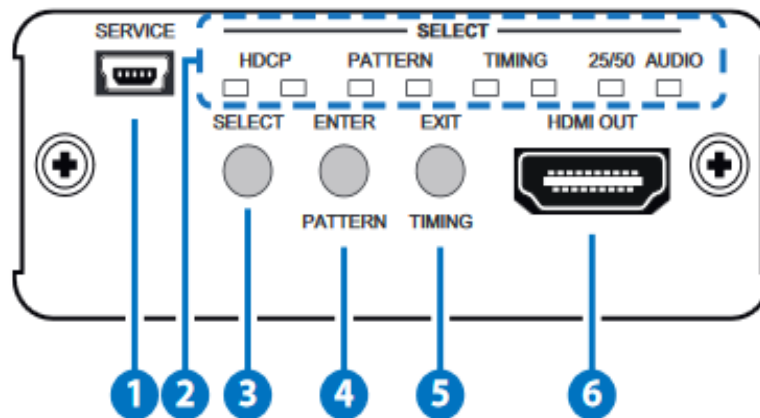





1. SERVICE:

This slot is reserved for factory use only.

2. SELECT LED:

These LEDs will illuminate according to the selection.

Each selection with 2 LEDs of 3 colors, left LED is blue and right LED are red or green. Each LED color represent a pattern/timing as below:

	Blue	Red	Green	None	25/50
					
HDCP LED	HDCP2.2	HDCP1.4*	OFF		
PATTERN LED	Blue Scale	Red Scale	Green Scale	Gray Scale *	
TIMING LED	4K2K60	4K2K30	1080P60	720P60*	
	4K2K50	4K2K25	1080P50	720P50	v
AUDIO LED		Optical	LR*		

*are default setting.

3. SELECT Button:

Press this button to enter into selection mode and both LEDs will be flashing in blue and green. Press again to enter into another selection.

4. ENTER/PATTERN Button:

Press this button to enter into the selection then press the SELECT button to select and the LED will illuminate in sequence from the default setting, press ENTER again to confirm the selection. When exit selection mode press this button to select pattern directly.

For example, to select HDCP 2.2 with blue scale and 4K2K60 timing from the default setting, press SELECT (to enter into selection) → press ENTER (to select HDCP) → press SELECT 2 times (to select HDCP2.2/Blue LED) → press ENTER (to confirm HDCP selection) → press SELECT again (to enter into PATTERN selection) → press ENTER (to select Patter) → press SELECT twice (to select Blue Scale/Blue LED) → press ENTER (to confirm Pattern selection) → press SELECT again(to enter into Timing selection) → press ENTER(to select Timing) → press SELECT 5 times(to select 4K2k60/Blue LED)) → and press ENTER (to confirm Timing selection).

Press ENTER together with EXIT to reset the setting back to default.

Note:

If the ENTER button is not pressed after the selection is made the setting will not be established and will remain under the selection mode.

5. EXIT/TIMING Button:

Press this button to exit/cancel the selection.

When exit selection mode press this button to select timing directly.

6. HDMI OUT:

Connect with display/monitor with HDMI cable.

Specifications

Video Bandwidth	600MHz/18Gbps
Input Port	1 x L/R (RCA) 1 x Optical 1 x USB(Service)
Output Ports	1 x HDMI
Supported Resolutions	720p@50/60, 1080p@50/60, 4K2K@25/30/50/60
HDMI Cable Length	5M/4K2K@25/30/50/60 5M/1080p@50/60
Support Digital Audio	48kHz Output Sampling Rate
Support Analog Audio	2Vrms
Power Supply	5V/2.6A DC (US/EU standards, CE/FCC/UL certified)
Chassis Material	Aluminum
Chassis color	Black
Weight	202g
Dimensions	78.5mm(W) x 95.25mm(D) x 30mm(H)
Power Consumption	2.5 W

Supported Resolutions

Resolutions	EMBEDDED	OUTPUT
1280×720p@50/60	√	√
1920×1080p@50/60	√	√
3840×2160@25/30/50/60	√	√

DVD or Blu-ray Player

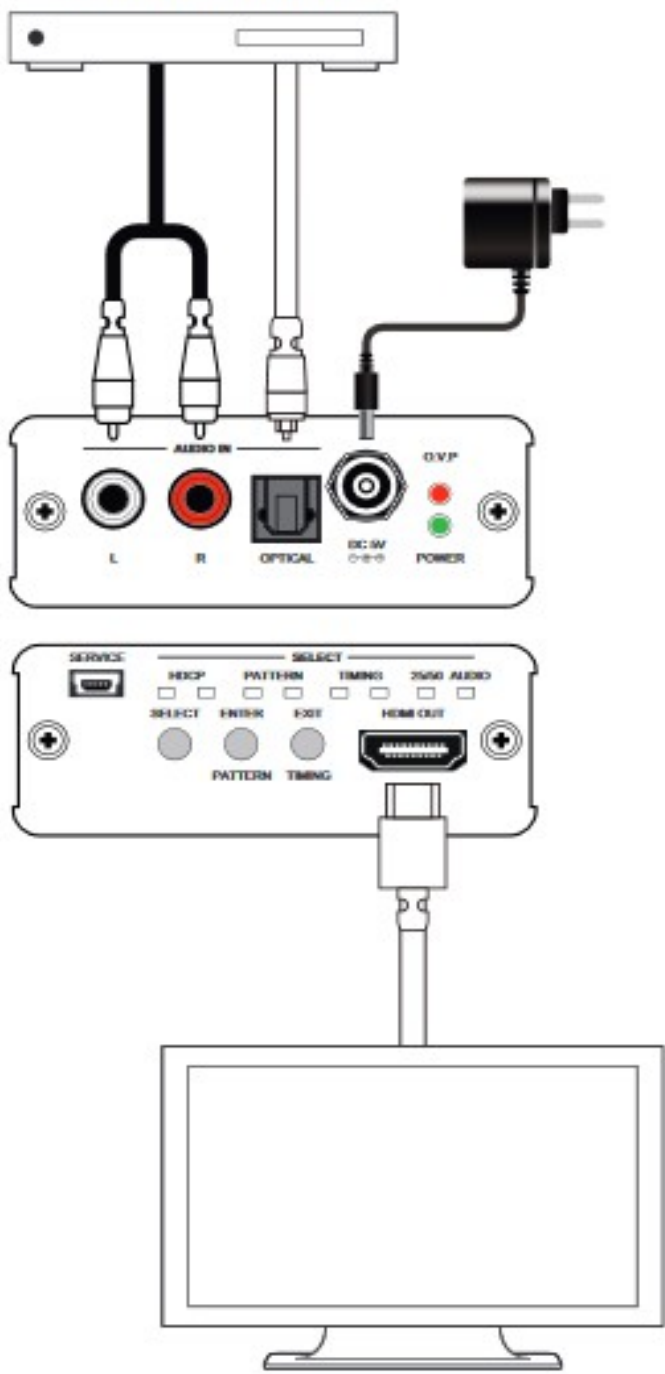

Amplifier or HD TV