

**4 SDI Input to 2 HDMI Output  
Switcher with Multi-view PiP - # 15401**



**Operation Manual**

## Introduction

The 4 by 2 SDI to HDMI Seamless Quad PIP Splitter is a high performance, high speed zooming/shrinking system that can be easily configure and control for quad or picture-in-picture video processing. Allowing 4 different SDI input sources to be freely selected and arranged on to HDMI displays with total of 8 different types of settings. Supporting resolution up to WUXGA@60RB, 1080p and audio up to 8CH with sampling rate 48kHz for both inputs and outputs. Screen setting hot keys, OSD, RS-232 and Telnet allows instant control and switching on the output displays.

## Applications

- Broadcasting room and control
- Surveillance room and control
- Public advertisement and control
- SDI signal extending

## Features

- Supports SD-SDI (SMPTE 259M-C, at bitrates of 270 Mbit/s) input signals up to 250M
- Supports HD-SDI (SMPTE 292M, at bitrates of 1.485Gbit/s and 1.485/1.001 Gbit/s) input signals up to 200M
- Supports 3G-SDI (SMPTE 424M/425M-AB, at bitrates of 2.970 Gbit/s and 2.970/1.001 Gbit/s) input signals up to 100M
- HDMI output compatible with DVI
- Combine four SDI inputs single into HDMI and output on to two synchronize HD screen
- Seamless switching between channels and windows
- Zoom and Shrink 4CH input image and or to overlay them
- Supports PIP, POP and multi-windows display
- Supports OSD, RS-232 Remote and on-panel controls
- Fade-In-Out, Chromakey, Mirror and Rotation (90° left & right and 180° up & down) functions
- 8 Screen setting hot keys and extra 4 customized favorite screen setting
- Easily to adjust size, position and setting of 4 input images via WebGUI, only drag and few clicks can achieve output display format setting

## System

### Requirements

Input source equipment such as SNG camera or SDI signal, PC/Laptop or RS-232 control devices and output HD TV/monitors with connection cables



## Operation Controls and Functions

### Front Panel

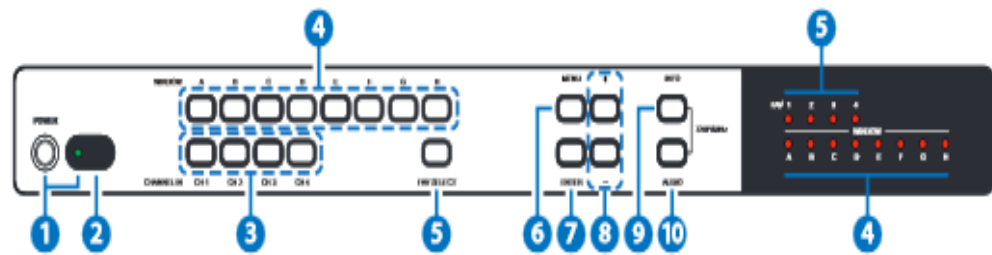

#### 1. POWER Button & LED:

Press this button to power on the device and the LED will illuminate in green or set it to standby mode and the LED will illuminate in Red.

#### 2. IR Window:

Accept IR signal from the device's remote control included in the package only.

#### 3. CHANNEL IN 1~4:

Press these buttons to rotate SDI 1~4 input source on each channel to be display on screens. All channels can select the same input or each channel a different input.

#### 4. WINDOW A~H & LEDs:

Press these hot keys to select the screen setting where A~D are display a full screen of each channel and E~H are a different combination of a full screen setting with all 4 channels.

Windows A~D's channel input selection is corresponding to channel input no. 1~4. That is, to change window A's input channel must press channel input 1's button. Channel input 2~4's button will not activate under window A's selection. Windows E~H's size are adjustable through the OSD menu setting and only window G & H is PIP(Picture in Picture) where E & F are POP (Picture out Of picture) settings.

Under window E~H when the size setting is overlapping one another, channel display sequence is CH4>CH3>CH2 >CH1. That is, CH4 will cover CH3 and CH3 will cover CH2 and so on. Under some display the borderline may have interference, adjusting display's motion setting may resolve the interference issue.

#### 5. FAV SELECT & LEDs:

Press this button to recall the favor setting from 1~4 and the LED will illuminate accordingly.

#### 6. MENU:

Press this button to bring up the OSD menu on screen.

#### 7. ENTER:

Press this button to enter into MENU selection and confirm the selection.

#### 8. +/- Buttons:

Press these buttons to scroll down/up the OSD selections.

#### 9. INFO:

Press this button to bring up the information section from the OSD menu.

#### 10. AUDIO:

Press this button to select audio channel.

**Note:** Press the 'INFO & AUDIO' buttons together to switch output resolution to 720p@60Hz instantly

### Rear Panel

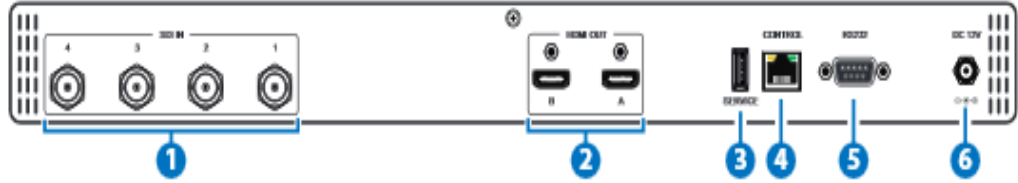

#### 1. SDI IN:

Connect with source equipment such as SNG camera or SDI signal devices.

#### 2. HDMI OUT:

Connect with HD TV/monitor for output image display.

#### 3. SERVICE:

This slot is reserved for factory use only.

#### 4. CONTROL:

Connect from PC/Laptop for Telnet control with RJ-45 cable.

#### 5. RS-232:

Connect from PC/Laptop/RS-232 equipped device with D-Sub 9pin cable for RS-232 command sending.

#### 6. DC 12V:

Plug the 12V DC power supply into the unit and connect the adaptor to an AC outlet.

### Remote Control

#### 1. Power:

Press this button to switch on the device or press it again to set it to standby mode.

#### 2. Info:

Press this button to show system information.

#### 3. Input CH 1~4:

Press these buttons to rotate SDI 1~4 input source on each channel to be display on screen

#### 4. WA~WH:

Press these hot keys to select the screen setting where WA~WD are display a full screen of each channel and WE~WH are a different combination of a full screen setting with all 4 channels.

#### 5. Mute:

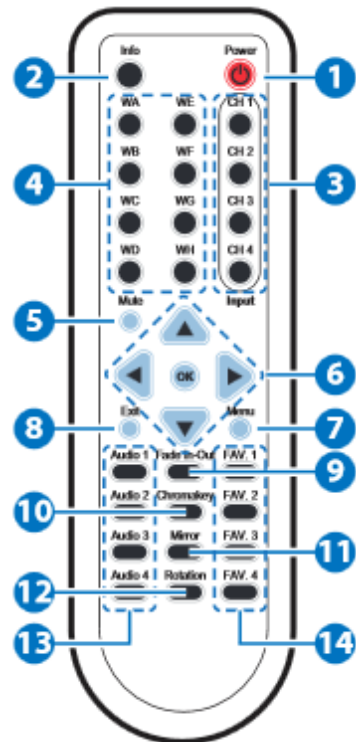

Press this button to mute the audio from HDMI output port.

**6. ▲/▼/▶/◀ & OK Buttons:**

Press this buttons to scroll through the OSD selection and press OK to enter and confirm the setting.

**7. Menu:**

Press this button to enter into the OSD menu.

**8. Exit:**

Press this button to exit the OSD menu or the OSD settings.

**9. Fade-In-Out\*:**

Press this button to switch on or off the Fade-in-out function.

**10. Chromakey\*:**

Press this button to enter into Chroma function where CH 1 is the background and CH 2 is the top image.

**11. Mirror\*:**

Press this button to display the screen in mirror image.

**12. Rotation\*:**

Press this button to rotate the image 90° left and right or 180° upside down.

**13. Audio 1~4:**

Press these buttons to select audio from SDI input source 1~4.

**14. FAV. 1~4:**

Press these buttons to bring up the customized screen settings.

**Note:** \*Functions only work under Window A to D. The system will force to switch to Window A when operate under Window E~H.

Main Menu	1 <sup>st</sup> Layer	2 <sup>nd</sup> Layer	3 <sup>rd</sup> Layer
<b>Image Adjust</b>	Brightness Adjust	CH1	0~100 (50)
		CH2	0~100 (50)
		CH3	0~100 (50)
		CH4	0~100 (50)
		Value Reset	
		Menu Exit	
	Contrast Adjust	CH1	0~100 (50)
		CH2	0~100 (50)
		CH3	0~100 (50)
		CH4	0~100 (50)
		Value Reset	
		Menu Exit	
	Saturation Adjust	CH1	0~100 (50)
		CH2	0~100 (50)
		CH3	0~100 (50)

		CH4	0~100 (50)
		Value Reset	
		Menu Exit	
	Picture Reset	CH1	0~100 (50)
		CH2	0~100 (50)
		CH3	0~100 (50)
		CH4	0~100 (50)
		Value Reset	
		Menu Exit	
	Menu Exit		
<b>Window Setup</b>	Channel 1 Select	Size	CH1 Wxxx Hxxx
			Width Unit
			Width Ten
			Width Hundred
			Height Unit
			Height Ten
			Height Hundred
		Position	CH1 Hxxx Vxxx
			Horizontal Unit
			Horizontal Ten
			Horizontal Hundred
			Vertical Unit
			Vertical Ten
			Vertical Hundred
	Priority	1~4	
	Image Output	On/Off	
	Window Reset		
	Menu Exit		
	Channel 2 Select	Size	CH1 Wxxx Hxxx
			Width Unit
Width Ten			

			Width Hundred
			Height Unit
			Height Ten
			Height Hundred
		Position	CH1 Hxxx Vxxx
			Horizontal Unit
			Horizontal Ten
			Horizontal Hundred
			Vertical Unit
			Vertical Ten
			Vertical Hundred
		Priority	1~4
		Image Output	On/Off
		Window Reset	
		Menu Exit	
	Channel 3 Select	Size	CH1 Wxxx Hxxx
			Width Unit
			Width Ten
			Width Hundred
			Height Unit
			Height Ten
			Height Hundred
		Position	CH1 Hxxx Vxxx
			Horizontal Unit
			Horizontal Ten
			Horizontal Hundred
			Vertical Unit
			Vertical Ten
			Vertical Hundred
		Priority	1~4
		Image Output	On/Off

	Window Reset	
	Menu Exit	
Channel 4 Select	Size	CH1 Wxxx Hxxx
		Width Unit
		Width Ten
		Width Hundred
		Height Unit
		Height Ten
		Height Hundred
	Position	CH1 Hxxx Vxxx
		Horizontal Unit
		Horizontal Ten
		Horizontal Hundred
		Vertical Unit
		Vertical Ten
		Vertical Hundred
	Priority	1~4
	Image Output	On/Off
	Window Reset	
Menu Exit		
Label2	VIDEO 1	
	VIDEO 2	
	VIDEO 3	
	VIDEO 4	
	Menu Exit	
Favors Store	FAV 1 Store	Yes/No
	FAV 2 Store	Yes/No
	FAV 3 Store	Yes/No
	FAV 4 Store	Yes/No
	Menu Exit	
Menu Exit		



<b>Window Convert</b>	Channel 1 Convert	Mirror	On/ <b>Off</b>
		Fade In-Out	On/ <b>Off</b>
		Rotation	R90/L90/Up-Side Down180/ <b>Off</b>
		Window Reset	
		Menu Exit	
	Channel 2 Convert	Mirror	On/ <b>Off</b>
		Fade In-Out	On/ <b>Off</b>
		Rotation	R90/L90/Up-Side Down180/ <b>Off</b>
		Window Reset	
		Menu Exit	
	Channel 3 Convert	Mirror	On/ <b>Off</b>
		Fade In-Out	On/ <b>Off</b>
		Rotation	R90/L90/Up-Side Down180/ <b>Off</b>
		Window Reset	
		Menu Exit	
	Channel 4 Convert	Mirror	On/ <b>Off</b>
		Fade In-Out	On/ <b>Off</b>
		Rotation	R90/L90/Up-Side Down180/ <b>Off</b>
		Window Reset	
		Menu Exit	
<b>ChromaKey Setup<sub>3</sub></b>	User 1	Minimum For Y 16~240	
		Maximum For Y 16~240	
		Minimum For Cb 16~240	
		Maximum For Cb 16~240	
		Minimum For Cr 16~240	
		Maximum For Cr 16~240	
		ChromaKey On/ <b>Off</b>	
	User 2	Minimum For Y 16~240	
		Maximum For Y 16~240	
		Minimum For Cb 16~240	
		Maximum For Cb 16~240	

		Minimum For Cr 16~240	
		Maximum For Cr 16~240	
		Chromakey On/ <b>Off</b>	
	White	Minimum For Y 234~235	
		Maximum For Y 234~235	
		Minimum For Cb 127~129	
		Maximum For Cb 127~129	
		Minimum For Cr 127~129	
		Maximum For Cr 127~129	
		Chromakey On/ <b>Off</b>	
	Yellow	Minimum For Y 218~220	
		Maximum For Y 218~220	
		Minimum For Cb 16~18	
		Maximum For Cb 16~18	
		Minimum For Cr 137~139	
		Maximum For Cr 137~139	
		<b>Switch On/Off</b>	
	Cyan	Minimum For Y 187~189	
		Maximum For Y 187~189	
		Minimum For Cb 152~154	
		Maximum For Cb 152~154	
		Minimum For Cr 16~18	
		Maximum For Cr 16~18	
		Chromakey On/ <b>Off</b>	
	Green	Minimum For Y 171~173	
		Maximum For Y 171~173	
		Minimum For Cb 40~42	
		Maximum For Cb 40~42	
		Minimum For Cr 25~27	
		Maximum For Cr 25~27	
		Chromakey On/ <b>Off</b>	
	Magenta	Minimum For Y 77~79	
		Maximum For Y 77~79	

		Minimum For Cb 213~215	
		Maximum For Cb 213~215	
		Minimum For Cr 228~230	
		Maximum For Cr 228~230	
		Chromakey On/ <b>Off</b>	
	Red	Minimum For Y 61~63	
		Maximum For Y 61~63	
		Minimum For Cb 101~103	
		Maximum For Cb 101~103	
		Minimum For Cr 239~240	
		Maximum For Cr 239~240	
		Chromakey On/ <b>Off</b>	
	Blue	Minimum For Y 30~32	
		Maximum For Y 30~32	
		Minimum For Cb 239~240	
		Maximum For Cb 239~240	
		Minimum For Cr 116~118	
		Maximum For Cr 116~118	
		Chromakey On/ <b>Off</b>	
	Black	Minimum For Y 16~17	
		Maximum For Y 16~17	
		Minimum For Cb 127~129	
		Maximum For Cb 127~129	
		Minimum For Cr 127~129	
		Maximum For Cr 127~129	
		Chromakey On/ <b>Off</b>	
	Exit		
<b>Ethernet Setup</b>	IP Mode	<b>Static/DHCP</b>	
	Time Out	10~60min/ <b>Off</b>	
	RE-Link	<b>Yes/No</b>	
	Exit		
<b>Sys Reset</b>	Yes/No		

<b>Information</b>	Screen Resolution		
	F/W Version		
	F/W Upgrade		
	Exit		
<b>Menu Exit</b>			

**Note:**

1. When in 'NATIVE' resolution, the unit will read the EDID settings of the display connected to HDMI OUT A.
2. Naming character up to 9 characters.
3. Chromakey Setup only works when CH 1 and CH 2 are selected. CH 1 is the background and CH 2 is the top layer to be overlaid. The RGB setting is for the CH2 video where the minimum setting figures cannot be greater than the maximum figures and the maximum figures cannot be lower than the minimum setting figures.
4. Figures in **BOLD** are default settings.

**RS-232 Protocol**

Splitter	
Pin	Assignment
1	NC
2	TX
3	RX
4	NC
5	GND
6	NC
7	NC
8	NC
9	NC

Remote Controller	
Pin	Assignment
1	NC
2	RX
3	TX
4	NC
5	GND
6	NC
7	NC
8	NC
9	NC

Baud Rate: 115200bps  
 Data bit: 8 bits  
 Parity: None  
 Flow Control: None  
 Stop Bit: 1



RS-232 and  
Telnet Controls

Command	Description	Parameter
?	Prints all available commands to the screen	
<b>Help</b>	Prints all available commands to the screen	
<b>SPOW 0/1</b>	Set the unit power on/off	0=Off 1=On
<b>RPOW</b>	Show current power state	
<b>SRES 0~18</b>	Set output resolution	0=480p@60Hz 1=576p@50Hz 2=720p@50Hz 3=720p@60Hz 4=1080p@24Hz 5=1080p@25Hz 6=1080p@30Hz 7=1080p@50Hz 8=1080p@60Hz 9=1024x768@60Hz 10=1280x800@60Hz 11=1280x1024@60Hz 12=1366x768@60Hz 13=1440x900@60Hz 14=1600x900@60Hz 15=1600x1200@60Hz 16=1680x1050@60Hz 17=1920x1200@60Hz 18=Native
<b>RrES</b>	Show current output resolution	
<b>SIODD 0/1</b>	Enable/disable on-screen information display	0=Off 1=On
<b>RIOSDD</b>	Show information OSD display current state	
<b>SOSDH 0~20</b>	Set OSD horizontal position	0~20
<b>ROSDH</b>	Show OSD horizontal position current	
<b>SOSDV 0~20</b>	Set OSD vertical position	0~20
<b>ROSDV</b>	Show OSD vertical position current	
<b>SOSDT 0/5~50</b>	Set OSD display time	0 =Off/5~50 (second)

<b>ROSDT</b>	Show OSD display current time	
<b>SOSDG 0~10</b>	Set OSD transparent value	0~10
<b>ROSDG</b>	Show OSD transparent current value	
<b>SBRI X Y</b>	Set brightness value for input channel	X=0/1~4, 0=All channels, 1~4=Channel 1~4 Y=0~100
<b>RBRI 0~4</b>	Show brightness current value	0=All channels, 1~4=Channel 1~4
<b>SCON X Y</b>	Set contrast value for input channel	X=0/1~4, 0=All channels, 1~4=Channel 1~4 Y=0~100
<b>RCON 0~4</b>	Show contrast current value	0=All channels, 1~4=Channel 1~4
<b>SSAT X Y</b>	Set saturation value for input channel	X=0/1~4, 0=All channels, 1~4=Channel 1~4 Y=0~100
<b>RSAT 0~4</b>	Show saturation current value	0=All channels, 1~4=Channel 1~4
<b>SPIRE</b>	Reset brightness, contrast, saturation all channel value to default	
<b>SIMRE 1~3</b>	Reset brightness or contrast or saturation value to default	1=Brightness 2=Contrast 3=Saturation
<b>SHSIZE X Y</b>	Set image horizontal size**	X=Channel 1~4 Y= 0~1920
<b>RHSIZE 1~4</b>	Show image horizontal size current value**	1~4=Channel 1~4
<b>SVSIZE X Y</b>	Set image vertical size**	X=Channel 1~4 Y= 0~1080
<b>RVSIZE 1~4</b>	Show image vertical size current value**	1~4=Channel 1~4
<b>SHPOS X Y</b>	Set horizontal position of specified channel**	X=Channel 1~4 Y= 0~1920
<b>RHPOS 1~4</b>	Show image horizontal position current value**	1~4=Channel 1~4
<b>SVPOS X Y</b>	Set vertical position of specified channel**	X=Channel 1~4 Y= 0~1080
<b>RVPOS 1~4</b>	Show image vertical position current value**	1~4=Channel 1~4
<b>SIMAGE X Y</b>	Set output channel image on/off**	X=Channel 1~4 Y= 0/1, 0=Off, 1=On

<b>RIMAGE 0~4</b>	Show output channel image current**	0=All channels, 1~4=Channel 1~4
<b>SPRI X Y</b>	Set windows priority**	X=Channel 1~4 Y=Priority 1~4
<b>RPRI 0~4</b>	Show windows priority**	0=All channels, 1~4=Channel 1~4
<b>SLABEL X Y</b>	Assign a preset name**	X=Channel 1~4 Y=A~Z and/or 0~9 (up to 9 characters)
<b>RLABEL 0~4</b>	Show preset name to screen**	0=All channels, 1~4=Channel 1~4
<b>SSTORE 1~4</b>	Save the current window to FAV1~FAV4**	1~4=FAV 1~4
<b>SRECALL1~12</b>	Set a output windows to Windows A~Windows FAV4	1=Window A, 2=Window B, 3=Window C, 4=Window D, 5=Window E, 6=Window F, 7=Window G, 8=Window H, 9=FAV 1, 10=FAV 2, 11=FAV 3, 12=FAV 4
<b>SMIRROR 0/1</b>	Set enable/disable mirror effect *	0=Off 1=On
<b>RMIRROR</b>	Show mirror current to screen*	
<b>SFADE 0~21</b>	Set fade in-out time*	0=Off, 1=1.0s, 2=1.1s, 3=1.2s, 4=1.3s, 5=1.4s, 6=1.5s, 7=1.6s, 8=1.7s, 9=1.8s, 10=1.9s, 11=2.0s, 12=2.1s, 13=2.2s, 14=2.3s, 15=2.4s, 16=2.5s, 17=2.6s, 18=2.7s, 19=2.8s, 20=2.9s, 21=3.0s (s=second)
<b>RFADE</b>	Show fade in-out current to screen*	
<b>SROTATE 0~3</b>	Set video rotation video to preset positions *	0=Off 1=R90 2=180 3=L90
<b>RROTATE</b>	Show video rotation current to screen*	
<b>SCHRKS 0~9</b>	Set chromaykey color for chroma key*	0=User 1 1=User 2 2=White 3=Yellow

		4=Cyan 5=Green 6=Magenta 7=Red 8=Blue 9=Black
<b>RCHRKS</b>	Show chromakey color current to screen*	
<b>SCHRC X Y</b>	Set the YCbCr color range for the chromakey*	X=0~11 0=User 1 Y Max 1=User 1 Y Min 2=User 1 Cb Max 3=User 1 Cb Min 4=User 1 Cr Max 5=User 2 Cr Min 6=User 2 Y Max 7=User 2 Y Min 8=User 2 Cb Max 9=User 2 Cb Min 10=User 2 Cr Max 11=User 2 Cr Min Y=16~240 (Value)
<b>RCHRC 0~9</b>	Show chromakey current to screen	0=User 1 1=User 2 2=White 3=Yellow 4=Cyan 5=Green 6=Magenta 7=Red 8=Blue 9=Black
<b>SCHRSW 0/1</b>	Set enable/disable chromakey effect*	0=Off 1=On
<b>RCHRSW</b>	Show chromakey effect current to screen*	
<b>SIPM 0/1</b>	Set IP mode to DHCP or Static	0=DHCP 1=Static
<b>RIPM</b>	Show current IP mode to screen	
<b>SIPADD XXX</b>	Set static IP address	xxx.xxx.xxx.xxx (xxx=0~255)
<b>RIPADD</b>	Show static current IP address to screen	
<b>SMAADD XXX</b>	Set static subnet address	xxx.xxx.xxx.xxx (xxx=0~255)
<b>RMAADD</b>	Show static current subnet address to screen	
<b>SGAADD XXX</b>	Set static gateway address	xxx.xxx.xxx.xxx



		(xxx=0~255)
<b>RGADD</b>	Show static current gateway address to screen	
<b>SETH 0~6</b>	Set Ethernet timeout	0=Off, 1=10m, 2=20m, 3=30m, 4=40m, 5=50m, 6=60m (m=minute)
<b>RETH</b>	Show Ethernet timeout current to screen	
<b>RELINK</b>	Relink the unit in 2 seconds	
<b>SMAC X</b>	Set MAC address	x=0~9 and/or A~F
<b>RMAC</b>	Show current MAC address to screen	
<b>IPCONFIG</b>	Show Ethernet address to screen	
<b>DEFAULT</b>	Reset the unit to factory defaults	
<b>SVICH X Y</b>	Set output video channel to specified source	X=Input 1~4 Y=0~4, 0=All channels, 1~4=Channel 1~4
<b>RVICH</b>	Show output channel the video source	
<b>SMUTE 0/1</b>	Set mute audio	0=Unmuted 1=Mute
<b>RMUTE</b>	Show current mute to screen	
<b>SAUDIO 1~4</b>	Set output audio to specified source	1~4=Input 1~4
<b>RAUDIO</b>	Show output audio source to screen	
<b>SCHRE 0~4</b>	Reset the Windows E~Windows FAV4 CH1~CH4 settings to factory defaults	0=All channels, 1~4=Channel 1~4
<b>SWICORE</b>	Reset the Windows A~Windows D settings to factory defaults	
<b>RBIOS</b>	Show bios version to screen	

**Note:**

- 1.Any commands will not be executed unless followed by a carriage return. Commands are case sensitive.
- 2.\*Commands are executable under Window A~D selection.
- 3.\*\*Commands are executable under Window E~H & FAV1~4

## Software Application

Please download the software from [www.cypress.com.tw](http://www.cypress.com.tw) with file name CDPS V2.000 and save it in a directory where you may use it later.

Connect the unit with PC/Laptop through the Ethernet port of an active network system and open the CDPS V2.000 application. Click on Find Devices on Network and a list of the devices connected to the system will show up.

Double click on the product name and an InfoFrom will appear to show the products' detail.

Find Devices on Network				
	Product Name	Description	IP Address	MAC Address
1	CDPS-4S2HSS	4 x 2 SDI to HDMI Seamless	192.168.1.50	F8:22:85:00:04:AA
2	CDPS-4KQ	4K2K TV Wall	192.168.5.145	F8:22:85:00:03:2A

Then user may use the IP Address to find the control device through Telnet or WebGUI or even RS-232/Hyper Terminal tools.

Product ID	0100
Product Name	CDPS-4S2HSS
MAC Address	F8:22:85:00:04:AA
IP Address	<input type="text" value="192.168.1.50"/>
Subnet Mask	<input type="text" value="255.255.255.0"/>
Gateway IP	<input type="text" value="192.168.5.254"/>
DNS	<input type="text" value="0.0.0.0"/>
IP Mode	<input type="text" value="Static"/>
Web GUI Port	<input type="text" value="80"/>
Telnet Port	<input type="text" value="23"/>
S / N	SN:123-456
Firmware Version	V0.09
Hardware Version	PCB-2108*B
Description	4 x 2 SDI to HDMI Seamless
Web GUI	<a href="#">Web GUI</a>
<input type="button" value="Save"/> <input type="button" value="Reboot"/>	

Note: The default IP setting is 192.168.1.50

## Telnet Control

To access the telnet control under MS windows, click 'Start' menu and type "cmd" in the search field then press enter.

Under Mac OS X, go to Go→Application→Utilities→Terminal.

See below for reference.

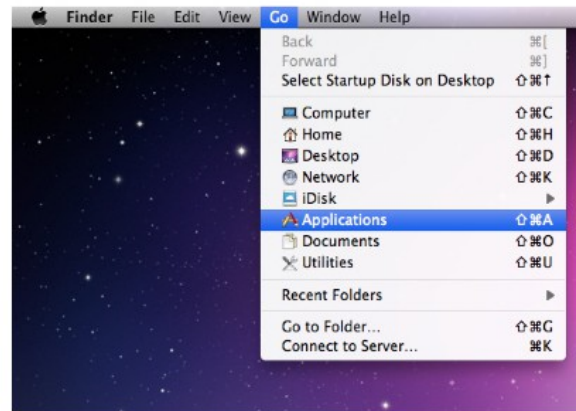
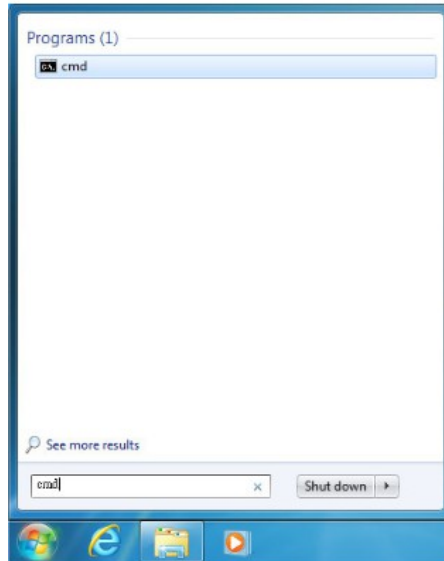

Once in the command line interface (CLI) type "telnet", then the IP address, and hit enter.

```
Microsoft Windows [Version 6.1.7601]
Copyright (c) 2009 Microsoft Corporation. All rights reserved.

C:\Users\Administrator>telnet 192.168.5.80 23
```

Press "Help" or "?" then hit enter to bring up all available commands

```
Command List
-----
HELP
SPOW
RPOW
SRRES
RRRES
SIOSED
RIOSED
SOSDH
ROSDH
SOSDU
ROSDU
SOEDT
ROEDT
SOSDG
ROEDG
SRRI
RRRI
S CON
R CON
SSAT
RSAT
SPIRE
SIMRE
S SIZE
R SIZE
SUSIZE
RUSIZE
SPOS
RPOS
SUFOS
RUFOS
SIMAGE
RIMAGE
SPRI
RPRI
SLABEL
RLABEL
SSTORE
RRECALL
SMIRROR
RMIRROR
SFADE
RFADE
SROTATE
RROTATE
SCHRS
RCHRS
SCHRC
RCHRC
SCHRSW
RCHRSW
SIPM
RIPM
SIPADD
RIPADD
SMAADD
RMAADD
SGAADD
RGAADD
SEHT
REHT
RELINK
EMAC
RMAC
IPCONFIG
DEFAULT
SUICH
RUICH
SMUTE
RMUTE
SAUDIO
RAUDIO
SCHRE
SMICORE
RBIOS
```

**Note:** Any commands will not be executed unless followed by a

carriage return. Commands are case-insensitive. If the IP is changed then the IP Address required for Telnet access will also change accordingly.

## WebGUI Control

On a PC/Laptop that is connected to an active network system, open a web browser and type device's IP address (default setting IP:192.168.1.50 ) on the web address entry bar. The browser will display device's Image Adjust, Output Resolution, Window Setup, OSD Settings, Window Convert, Chromakey Setup & Ethernet pages for users to control.

### Image Adjust

Click on 'Image Adjust' to show current I/O information and Channel input status. Set power status, select source settings and adjust each channel's contrast, brightness and saturation, or to set the setting back to default.

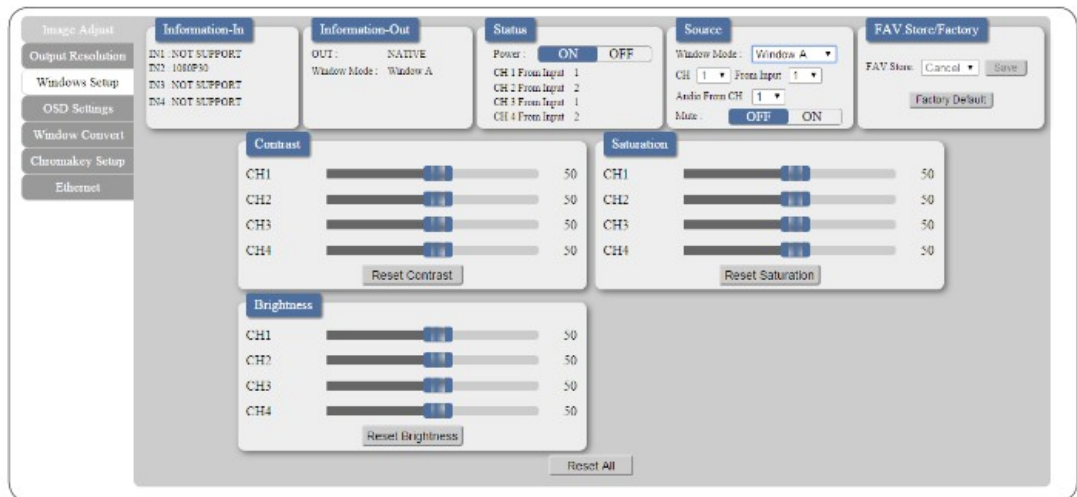

### Output Resolution

Click on 'Output Resolution' to select both output ports' resolution, default setting is on Native and the device will reference output A's EDID

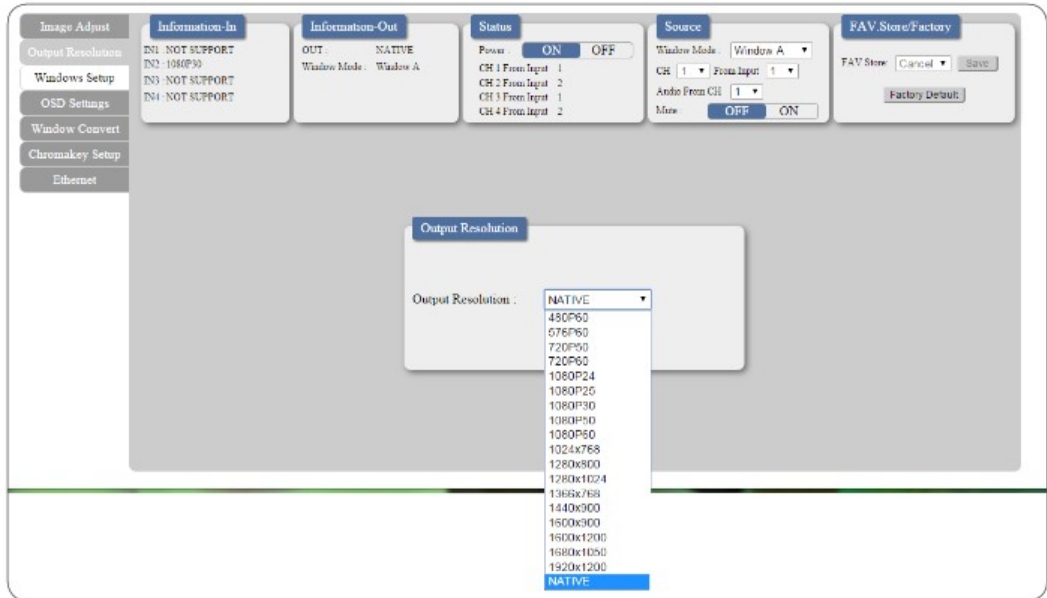

## Window Setup

Click on 'Windows Setup' to select the window display format from E~H with its size and position, simply drag and pull each channel to the desired position. Once the setting is done it can be labeled and saved.

**Note:** This page is only selectable under Window mode E~H and under these modes Window Convert and Chromakey Setup will not be selectable.

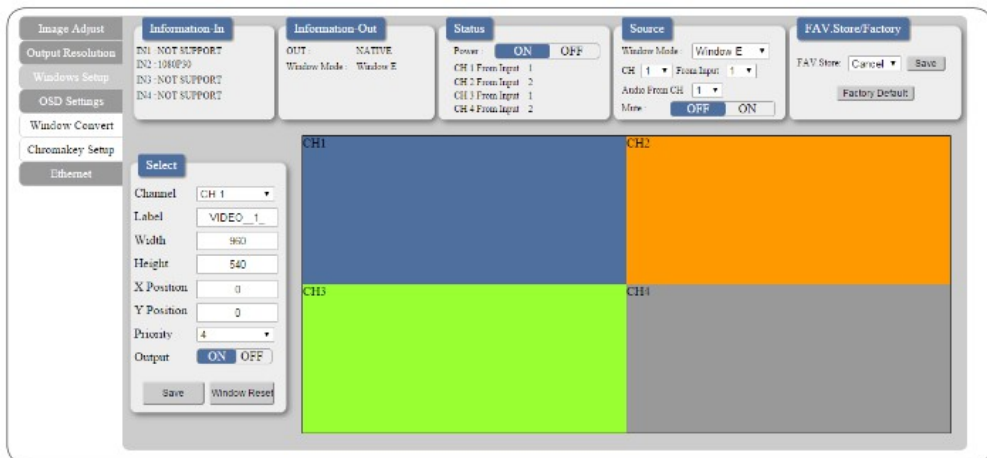

## OSD Settings

Click on 'OSD Settings' to set OSD size, timeout and transparent settings and allow info display On or Off

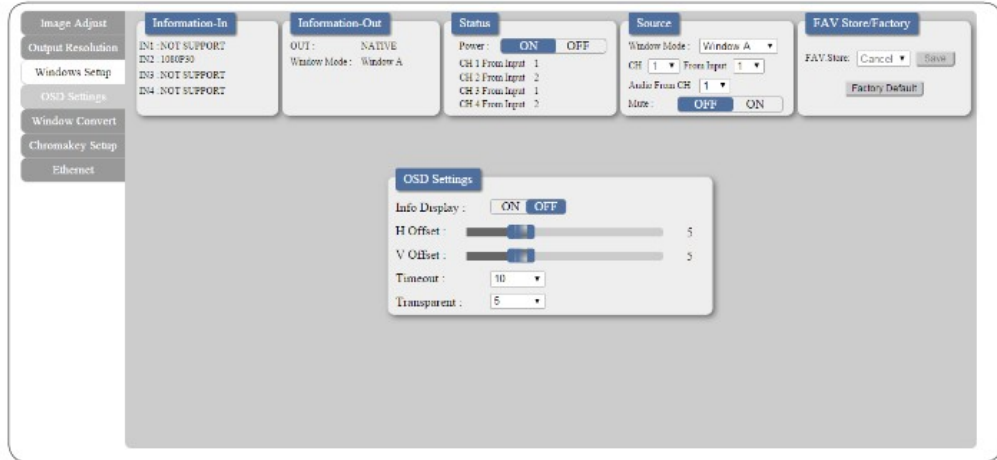

## Window Convert

Click on 'Window Convert' to set each window's appearance by mirror, fade-in-out or rotation.

Note: This page is only selectable under Window mode A~D

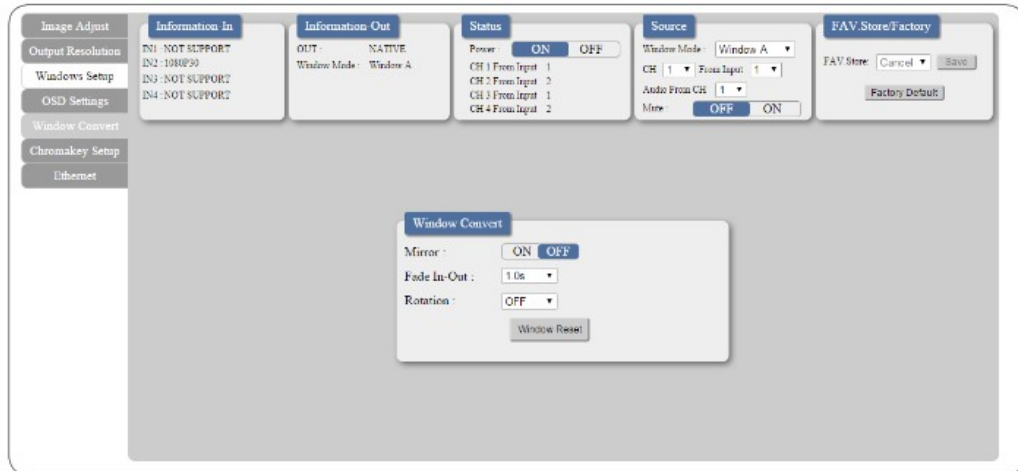

## Chromakey Setup

Click on 'Chromakey Setup' to set each window's chromakey.  
Note: This page is only selectable under Window mode A~D.

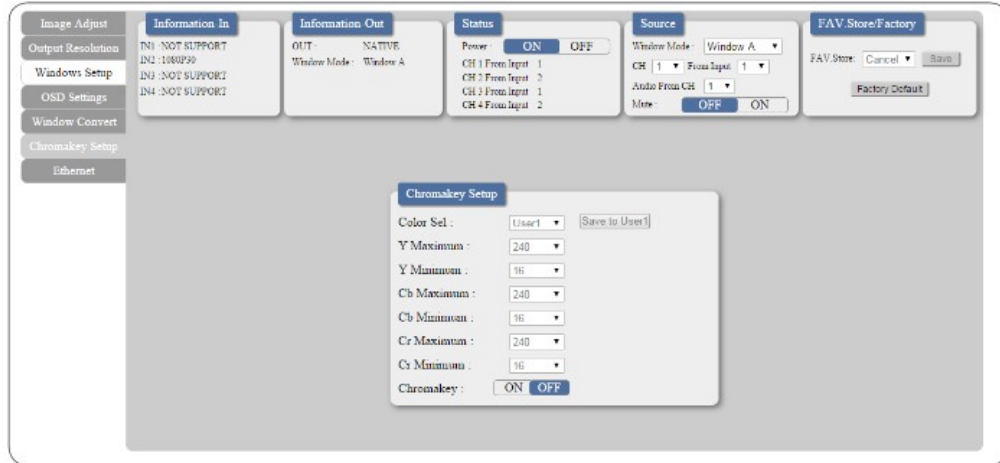

## Ethernet

Click on 'Ethernet' to set IP status, IP address and other IP related setting.

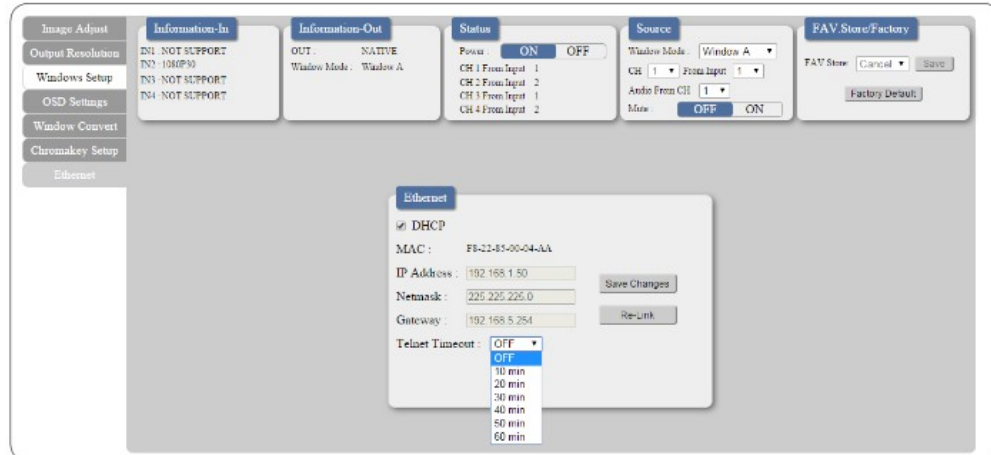



## Specifications

<b>SMPTE Standards</b>	259M-C, 292M, 424M/425M-AB
<b>SDI Transmission Rates</b>	270Mbps, 1.485Gbps & 1.485/1.001Gbps, 2.970Gbps & 2.970/1.001Gbps
<b>Video Bandwidth</b>	225MHz/6.75Gbps
<b>Input Ports</b>	4×SDI
<b>Output Ports</b>	2×HDMI
<b>SDI Timings Support</b>	SD-SDI: SMPTE 259M-C@270Mbps HD-SDI: SMPTE292M@1.485 & 1.485/1.001Gbps 3G-SDI: SMPTE 424M/425M-AB@2.970 & 2.971/1.001Gbps
<b>HDMI Timings Support</b>	480i, 576i, 720p@50/59.94/60, 1080i@50/59.94/60, 1080p@23.98/24/25/29.97/30/50/59.94/60 & 1080PsF@23.98/24/25/29.97/30
<b>SDI Cable Length</b>	250m@SD-SDI, 200m@HD-SDI, 100m@3G-SDI (BELDEN 1694A cable)
<b>HDMI Cable Length</b>	5M/1080p@50/60
<b>ESD Protection</b>	Human Body Model: ±8kV (air-gap discharge) ±4kV (contact-gap discharge)
<b>Power Supply</b>	12V/3A DC (US/EU standards, CE/FCC/UL certified)
<b>Dimensions</b>	482mm(W)×274mm(D)×52mm(H)
<b>Weight</b>	2976g
<b>Chassis Material</b>	Metal
<b>Silkscreen Color</b>	Black
<b>Operating Temperature</b>	0 °C~40 °C / 32 °F~104 °F
<b>Storage Temperature</b>	20 °C~60 °C / -4 °F~140 °F
<b>Relative Humidity</b>	20~90% RH (non-condensing)
<b>Power Consumption</b>	20W

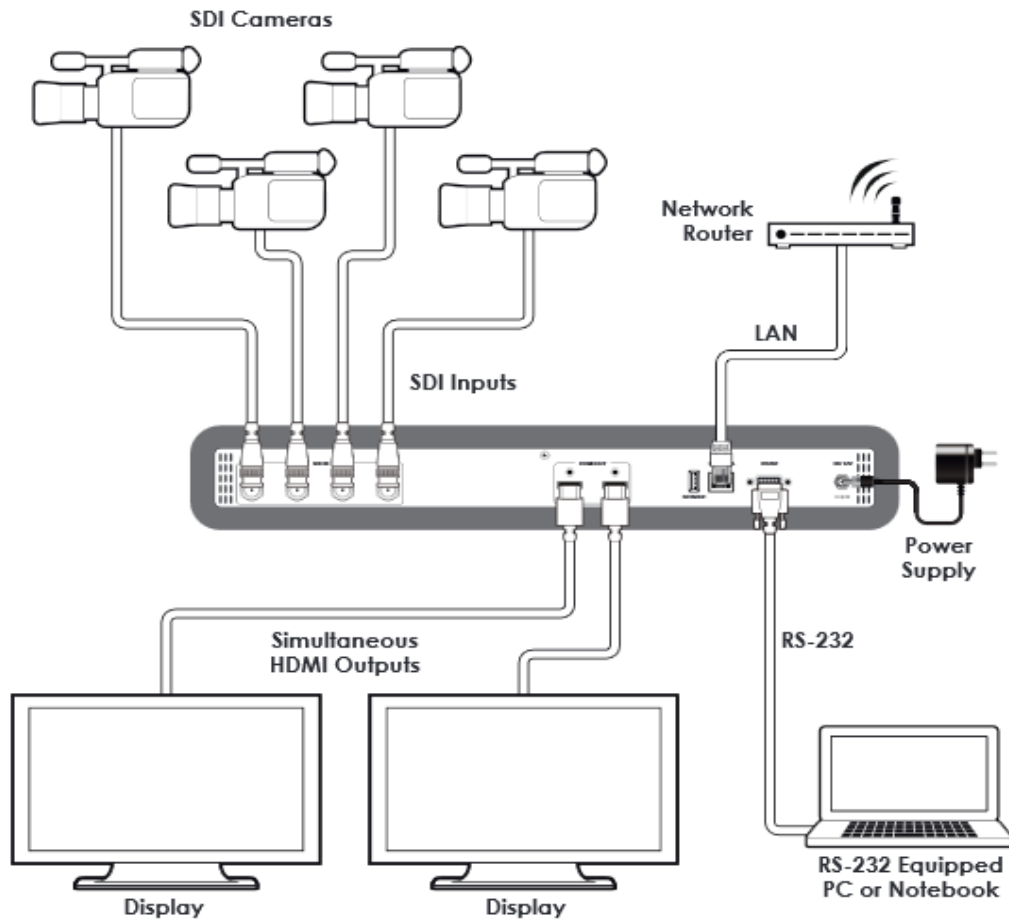

**Screen Configurations**

