

**15 Inch Desk Mount Multi-Frequency
CGA/EGA/VGA LCD Panel ID#970**



Operation Manual



Introduction

This monitor is a Desk Mount Multi Frequency LCD Panel monitor. It features the VESA plug & play system which allows the monitor to automatically adjust itself to match the frequency of the user's device.

Features

- High brightness.
- Fast response time.
- Power saver.
- Low electromagnetic wave and power saver.
- Safety certifications.
- CGA, EGA and VGA multi-system

Power Saver

- The power control system is installed inside the LCD monitor.
- If the monitor has not been used for a certain period of time, the system will turn the monitor to low voltage mode to save power. Any button press will return the monitor to original state.
- Your input device e.g. your computer controls the power saver mode. You can adjust these settings via your computer
- The LCD monitor is compatible with EPA Energy Star and N Tek if used with a VESA DPMS computer.
- To save power, turn off the power of the LCD monitor when it is not in use.

Plug and Play

- The VESA plug and play function eliminates the complicated and time-consuming installation process.
- As this is a plug and play monitor. Your computer system can easily identify and automatically adjust the monitor.
- The LCD monitor uses Display Data Channel (DDC) to send Extended Display Identification Data (EDID) to the computer system, so the computer system can be set to monitor auto adjust.

Setting up your LCD monitor

Screen Adjustment

To enter adjust mode, please refer to the OSD control.

- Turn the computer and LCD monitor on.
- Press “Auto” button to start auto adjust.
- This will start the auto adjust process. This will take approximately 10 seconds. You may notice the image changing and occasionally flashing (this is normal).
- Your LCD monitor provides a self testing function, through which you can check whether the LCD monitor functions are working properly.
- If your LCD monitor is properly connected, but there is no image showing and the indicator lights up in orange, please follow the below steps:
 - Shutdown the computer and the LCD monitor.
 - Unplug the signal connector from the back of the computer.
 - Turn the LCD monitor on.
 - If the image connector is disconnected or damaged, a “No signal input” sign will pop up on the monitor.



NO SIGNAL INPUT

- Turn off the LCD monitor and reconnect the signal cable, and then turn the computer and LCD monitor on.
- If the LED of the LCD monitor is an orange colour after completing the steps above, please check your VGA card and computer system. Your monitor should be operating properly.



OUT OF RANGE

- If the “out of range” error pops up on the monitor, the input frequency is outside of the specified range and will not display an image. The correct frequency will need to be entered and then restart the monitor.

Panel Controls

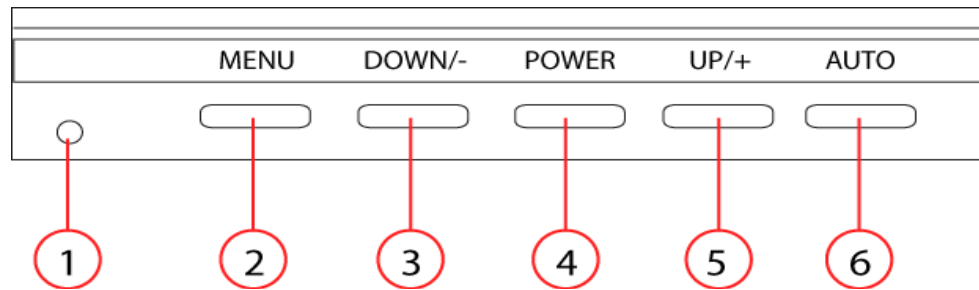

1.	LED	Green : Power On
		Red : Standby or not connected
		Off : Power off
2.	Menu	This button is used to display the ON Screen Display (OSD) menu.
3.	Down/-	This button is used for selection or adjustment when OSD is shown and decreasing volume..
4.	Power Switch	Power On/Off.
5.	Up/+	This button is used for adjustment when OSD is shown and increasing volume.
6.	Auto	Automatically optimize positions, phase and clock when OSD is not shown.

Adjusting the Image

- Press the menu button to start the OSD feature.
- Click the “Up” or “Down” button to select the function to be adjusted.
- Click the “Menu” button to access into the function to be adjusted.
- Click the “Up” or “Down” button to change the current setting of the function selected.
- To exit the OSD menu or go back to a previous menu click the “Auto/Esc” button. Upon exiting the menu your changes will automatically saved.
- If after pressing the menu button, the OSD button will disappear, if no additional buttons are pressed for several seconds. If this occurs, any adjustments made, will still be automatically saved.
- Due to the automatic save feature, turning off the power is unwise while navigating the menu.

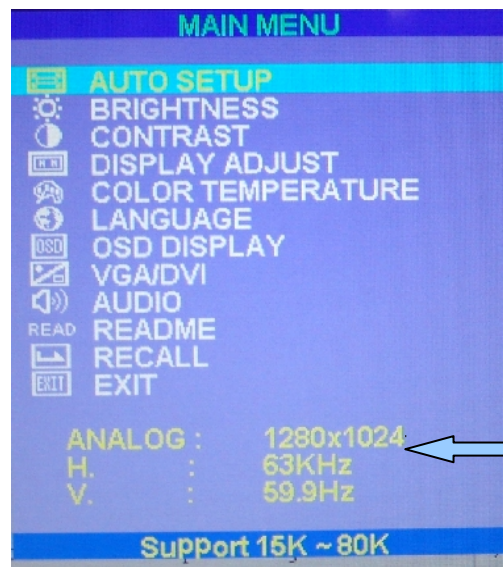

Detects and displays current input setting

Please Note: Due to the advanced nature of this panel. Adjustments to clock, phase and image positioning are saved only for the signal timing you are currently using. Meaning if your input is CGA 640 x 215 @60Hz, and you adjust the clock setting. This will only affect this timing.

So when your change input to VGA 640 x 480 @60Hz for example the clock will be at its default (or last memory saved setting). This is to allow the user to get a picture perfect for every input he requires and avoid redoing settings each time the input is changed. Except for these adjustments, clock, phase and image positioning, all other adjustments are universal for example changing the brightness setting will change the brightness setting for all inputs and timings.

To help the User remember; all settings that only affect the timing you're currently using are coloured pink and the universal settings are coloured white.

**OSD Menu
Options**

Menu		
Auto Setup	Automatically optimize positions, phase and clock	
Brightness	Brightness	Adjust Screen Brightness
	Recall	Restore to Default
	Return	Exit menu
Contrast	Adjust the Screen Contrast	
Display Adjust	H Position	Adjust the Horizontal Positioning
	V Position	Adjust the Vertical Positioning
	V Size	Adjust the Vertical Screen Size
	Clock	Adjusts horizontal alignment
	Phase	Adjusts horizontal alignment
	Quality	Adjusts the quality of the image
	Mode Selection	Default Analog VGA in
	Recall	Restore to Default
	Return	Exit menu
Colour Temperature	9300k	Set up the colour temp. to be 9300 K white colour.
	7500k	Set up the colour temp. to be 7500 K white colour.
	6500k	Set up the colour temp. to be 6500 K white colour.
	Auto Gain	Auto Colour adjustment
	Red	Adjust the Red colour values
	Green	Adjust the Green colour values
	Blue	Adjust the Blue colour values
	Return	Exit menu
Language	Choose language from English, French, Italian, Chinese, Japanese	

OSD Display	OSD H-Pos	Position the OSD menu horizontally on screen
	OSD V-Pos	Position the OSD menu vertically on screen
	OSD Timer	Set the OSD menu on screen display time
	OSD Transparency	Set the OSD menu Transparency
	OSD Direction	Set the direction of the OSD menu : Normal, Mirror, Left, Right, Up or Down
	Display Logo	Display Logo
	Recall	Restore to Default
	Return	Exit Menu
VGA/DVI	Analog Input	Selects VGA input
	Digital Input	Unavailable
	Return	Exit Menu
Audio	Audio	Mute Audio
	Volume	Adjust the volume
	Recall	Restore to default
	Return	Exit menu
Read me	Quick start Guide	
Recall	Restore to default	
Exit	Restore to default	

Warning: Phase and Clock Settings shouldn't be touched unless you know what you're doing. Altering these values can make the image unwatchable on the screen

**Support
CGA/EGA/VGA
Timings**

Type	H. Frequency. (kHz)	V. Frequency (Hz)	Resolution
CGA	15.4	58.8	640x198
CGA	15.1	57.6	640x215
CGA	15.7	60	640x215
CGA	16.0	61	640x215
CGA	16.3	62	640x215
CGA	16.6	63.4	640x215
CGA	16.800	64	640x215
CGA	15.6	50.3	640x265
CGA	18.4	50	640x350
VGA	31.469	70.087	640x400
VGA	31.469	59.940	640x480
VGA	35.000	66.667	640x480
VGA	37.861	72.809	640x480
VGA	37.500	75.000	640x480
SVGA	35.156	56.250	800x600
SVGA	37.879	60.317	800x600
SVGA	48.077	72.188	800x600
SVGA	46.875	75.000	800x600
XGA	48.363	60.004	1024x768
XGA	48.78	59.561	1024x768
XGA	56.476	70.069	1024x768
XGA	60.023	75.029	1024x768
SXGA	47.732	60.024	1280x768
SXGA	60.168	75.019	1280x768
SXGA	60.000	60.000	1280x960
SXGA	63.981	60.020	1280x1024
SXGA	79.976	75.025	1280x1024
Additional Timings			
	31.469	70.087	720x400
	49.726	74.551	832x624
	67.500	75.000	1152x864
	68.681	75.062	1152x870
	61.795	65.950	1152x900
	71.809	76.149	1150x900
	47.700	60.000	1360x768
	55.935	59.887	1440x900
	70.640	74.980	1440x900

Above is just a guide, many other frequencies are accepted

Connecting into Monitor

Option 1 - Using VGA Input

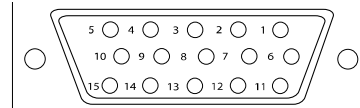

By using a standard VGA 15 pin computer cable plug and play or, alternatively you may cut the end of your cable and wire directly to the output connector of the source equipment.



Pin 1	Analog red input.
Pin 2	Analog green input.
Pin 3	Analog blue input.
Pin 4	Ground.
Pin 5	Digital ground.
Pin 6	Analog red ground.
Pin 7	Analog green ground.
Pin 8	Analog blue ground.
Pin 9	Ground.
Pin 10	Sync ground.
Pin 11	Ground.
Pin 12	SDA (DDC Data).
Pin 13	H. Sync or H + V Sync.
Pin 14	V. sync.
Pin 15	SCL (DDC CLK).

Option 2 - RGB wiring via Adapter PCB

The PCB interface board is designed to facilitate connection from older style CGA/EGA/VGA source equipment. The board also allows for adjustment of incoming colour signal levels and Impedance Matching selection.

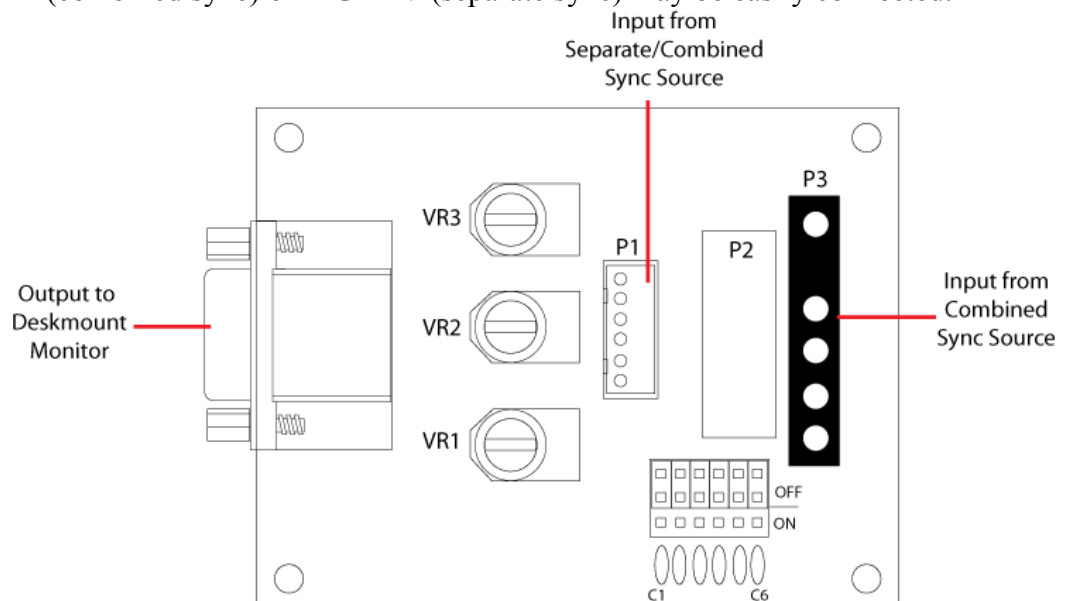
Using the supplied 5 and 6 wire open ended cables, signal formats of RGBH+V (combined sync) or RGBHV (separate sync) may be easily connected.

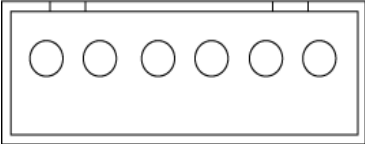

P1 – RGBHV separate/combined sync	P3 – RGBH+V combined sync
R G B E H/S V 	R G B E H/S 
Pin 1 – Red	Pin 1 – Red
Pin 2 – Green	Pin 2 – Green
Pin 3 – Blue	Pin 3 – Blue
Pin 4 – Signal Earth	Pin 4 – Signal Earth
Pin 5 – Horizontal/Combined Sync	Pin 5 – Horizontal/Combined Sync
Pin 6 – Vertical Sync	

About Our Adapter PCB and Further Adjustments

Our adapter PCB offers a number of adjustments via the following controls

-VR1 to VR3

Adjust to vary the level of the individual output colour signals to compensate for over exposure/brightness of video image.

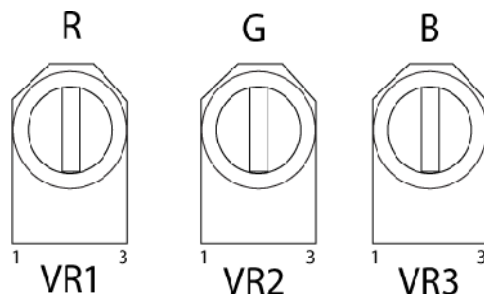

VR1 – Red
VR2 – Green
VR3 – Blue

| Adjusts colours to reduce the
| signal strength if image is
| over bright

Filter Jumpers

Set Jumpers as required to reduce effect of black line artifacts when low resolution mismatch becomes evident on LCD screen. By setting to "ON" position, each colour can be filtered as required.

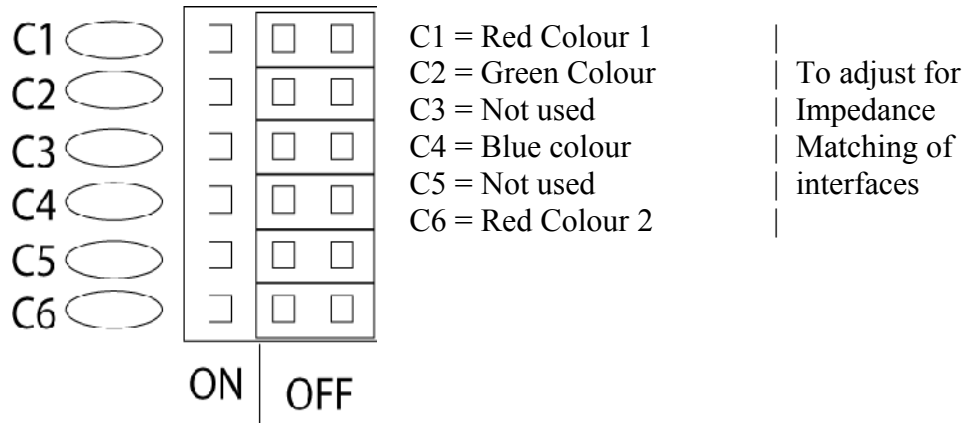

Front/Side View

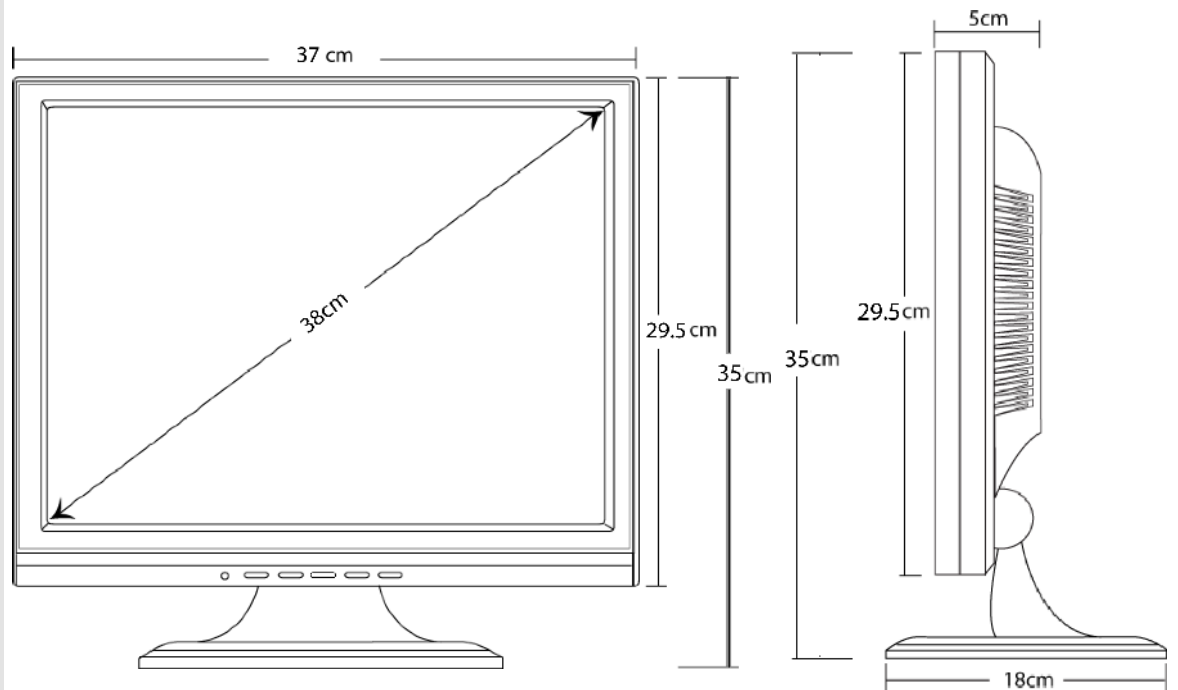

Specifications

Specifications for this Model	
Screen Size	15" TFT
Pixel Pitch(mm)	0.264 x 0.264
Backlight	2xCCFL
Cell Type	TN
Input Mode	CGA/EGA/VGA/SXGA
Scan Frequency Horizontal	15 ~ 80KHZ
Scan Frequency Vertical	48 ~ 75Hz
Colours	16.7M Colors
Aspect Ratio	5:4
Horizontal Viewing Angle	Full range
Max Resolution	1280 x 1024
Bandwidth	130MHz Dot Clock
Contrast Ratio	500:1 Typ
Brightness	250cd/m2
Power	100~240V 47/63Hz via 12VDC 4A adapter
Power Consumption	13.35 Watts(Typ.)
Management	Vesa-Dpms 42 watts Power down mode </=3 Watts
Function Keys	5
PC Interface	Analog Interface
Signal Cable	Standard VGA cable w/15-pin D-sub connector. Or via VGA Inverter PCB
Operating Temperature	0 degrees ~ +50 Degrees
Humidity	10 ~ 85%

Troubleshooting

Error	Solution
No Power Led	Check Mains Power supply input Voltage (100v or 240vAC) and connection
	Check 12V DC at power supply output
	Check control board for damage
No image	Check cables connected correctly from source and into monitor inputs
	Check correct orientation of signal wires; H-sync and V-sync
	Check for CCFL lamp operation on rear of lcd panel, visual reference only
	Check power 'on' source and monitor
Image Alignment	Adjust using “AUTO” button
	Fine adjust using the OSD Menu parameters accordingly for Horizontal and Vertical position/size
Image Brightness/Contrast	Adjust OSD Menu parameters for Brightness and Contrast
Image colour	Check RGB colour wires connected and active
	Adjust OSD Menu parameters for colour temperature and colour intensity
Intermittent Image	Ensure equipment is earthed and isolated from signal earths, <i>Note:</i> Isolation (No Earth) sometimes improves image reception
	Ensure open wire cables are sheathed and earthed against EFI (Electromagnetic Field Interference)
	Check all cable pins aligned and seated correctly